

Mobilkran · Mobile Crane Grue automotrice

LG 1750

Technische Daten
Technical Data
Caractéristiques techniques

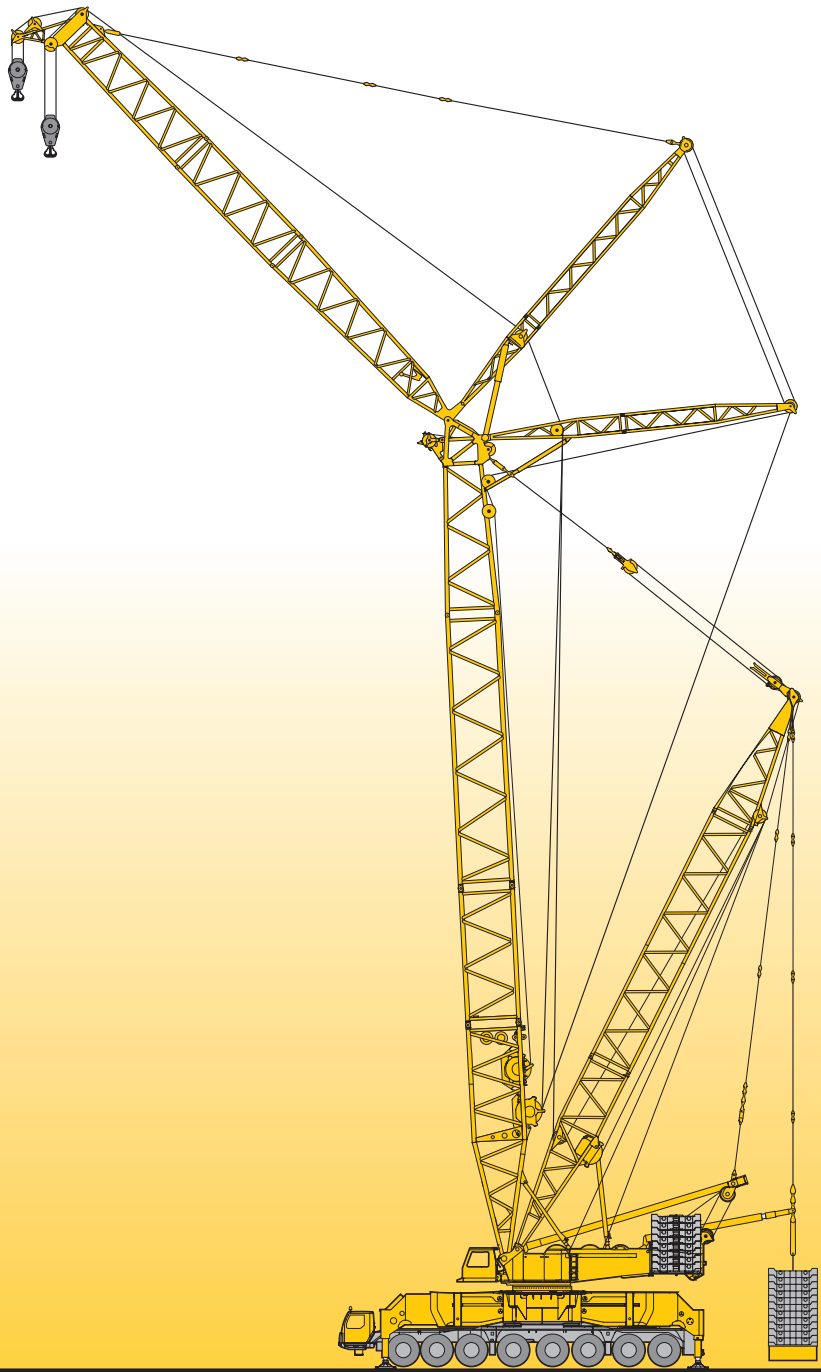

LIEBHERR

Inhaltsverzeichnis

Table of content

Tables des matières

Inhaltsverzeichnis

Maße und Geschwindigkeiten	3 – 5, 11 – 13
Transportplan	6 – 7
Aufbau	8 – 10
Lastaufnahmemittel und Einscherplan	14
Transportplan und Auslegersystem	15 – 17
Traglasten und Hubhöhen am S-Auslegersystem	18 – 21
Traglasten und Hubhöhen am SL-Auslegersystem	22 – 25
Traglasten und Hubhöhen am SL8HS-Auslegersystem	26 – 29
Traglasten und Hubhöhen am SLK-Auslegersystem	30 – 33
Traglasten und Hubhöhen am SD-, SDB- und S2DB-Auslegersystem	34 – 38
Traglasten und Hubhöhen am SD2- und SD2B-Auslegersystem	39 – 42
Traglasten und Hubhöhen am SLD- und SLDB-Auslegersystem	43 – 46
Traglasten und Hubhöhen am SL9D2F- und SL9D2FB-Auslegersystem	47 – 50
Traglasten und Hubhöhen am SW-Auslegersystem	51 – 66
Traglasten und Hubhöhen am SDW- und SDWB-Auslegersystem	67 – 87
Technische Beschreibung, Kranfahrgestell, Kranoberwagen, Auslegersysteme und Zusatzausrüstung	88 – 89
Anmerkungen zu den Traglasttabellen	92

Table of content

Dimensions and working speeds	3 – 5, 11 – 13
Transportation plan	6 – 7
Assembly	8 – 10
Hook blocks and hooks, reeving chart	14
Transportation plan and boom/jib combinations	15 – 17
Lifting capacities and heights on S boom	18 – 21
Lifting capacities and heights on SL boom	22 – 25
Lifting capacities and heights on SL8HS boom	26 – 29
Lifting capacities and heights on SLK boom	30 – 33
Lifting capacities and heights on SD, SDB and S2DB boom/derrick combination	34 – 38
Lifting capacities and heights on SD2 and SD2B boom/derrick combination	39 – 42
Lifting capacities and heights on SLD and SLDB boom/derrick combination	43 – 46
Lifting capacities and heights on SL9D2F and SL9D2FB boom/derrick combination	47 – 50
Lifting capacities and heights on SW boom/jib combination	51 – 66
Lifting capacities and heights on SDW and SDWB boom/derrick combination	67 – 87
Technical description, crane carrier, crane superstructure, boom systems and optional equipment	89 – 90
Remarks referring to load charts	92

Tables des matières

Les dimensions et les vitesses	3 – 5, 11 – 13
Plan de transport	6 – 7
Assemblage	8 – 10
Organes de préhension et tableau de mouflage	14
Plan de transport et les configurations de flèche	15 – 17
Les forces de levage et hauteurs de levage en configuration S	18 – 21
Les forces de levage et hauteurs de levage en configuration SL	22 – 25
Les forces de levage et hauteurs de levage en configuration SL8HS	26 – 29
Les forces de levage et hauteurs de levage en configuration SLK	30 – 33
Les forces de levage et hauteurs de levage en configuration SD, SDB et S2DB	34 – 38
Les forces de levage et hauteurs de levage en configuration SD2 et SD2B	39 – 42
Les forces de levage et hauteurs de levage en configuration SLD et SLDB	43 – 46
Les forces de levage et hauteurs de levage en configuration SL9D2F et SL9D2FB	47 – 50
Les forces de levage et hauteurs de levage en configuration SW	51 – 66
Les forces de levage et hauteurs de levage en configuration SDW et SDWB	67 – 87
Description technique, châssis porteur, partie tournante, systèmes de flèches et les équipements additionnel	90 – 91
Remarques relatives aux tableaux des charges	92

Maße Dimensions Encombrement

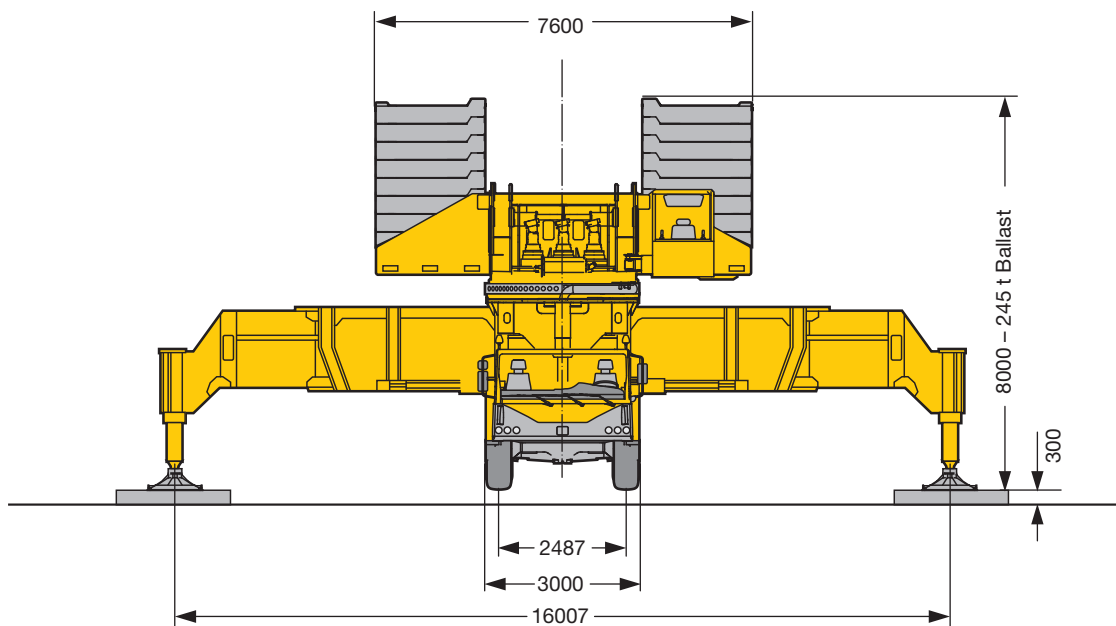
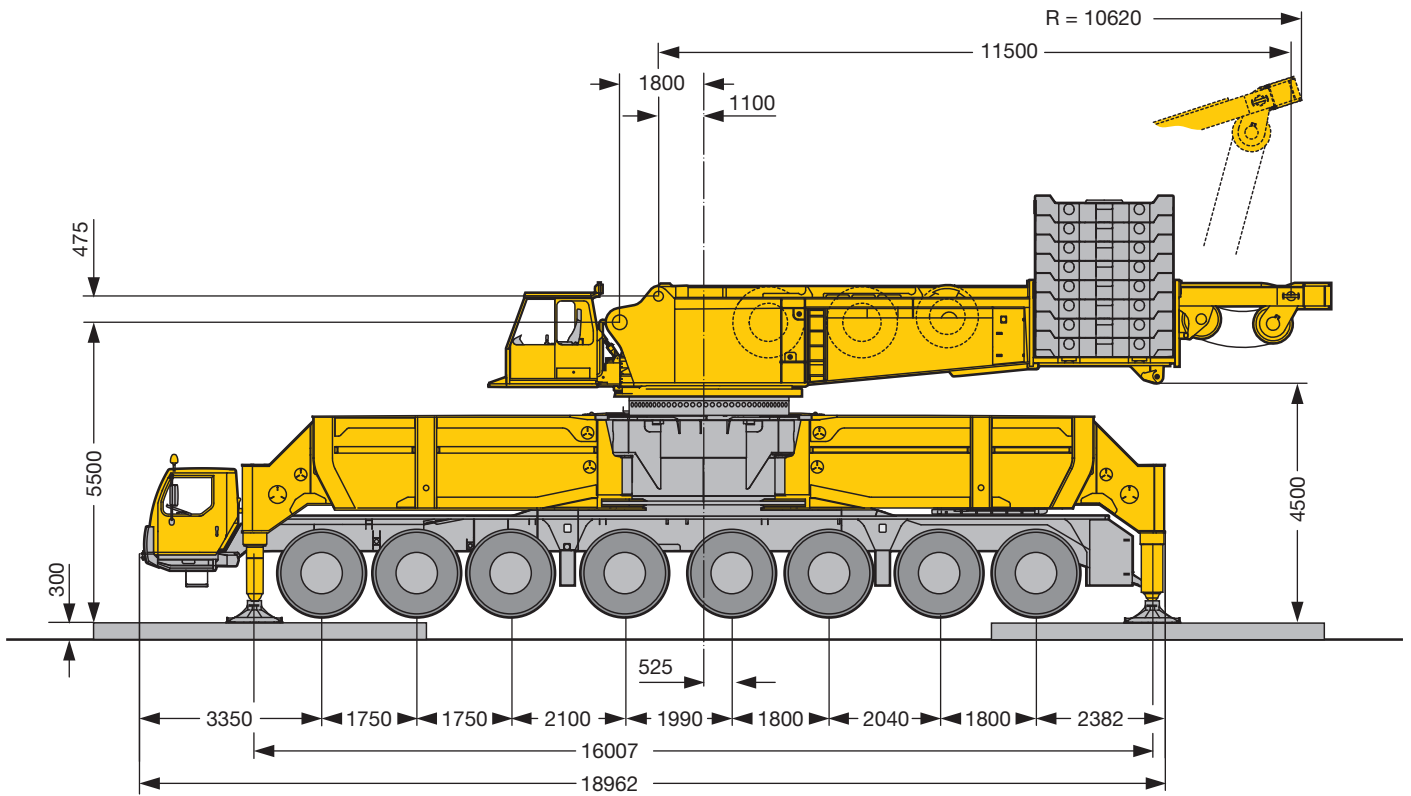

S1575.01

Maße Dimensions Encombrement

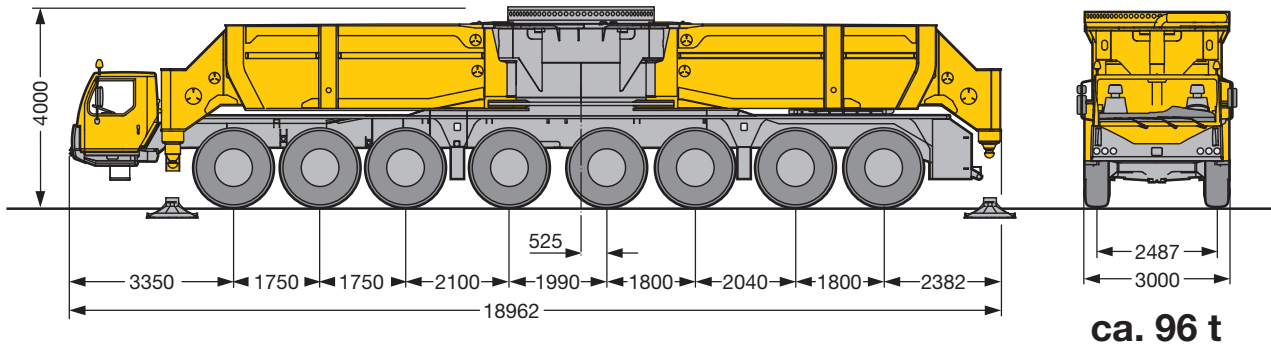

ca. 96 t

Bei Straßenfahrt hintere Klappholme 300 mm ausgefahren.
On-road travel rear outriggers 300 mm extended.
Pour déplacement sur route sortir les poutres de calage arrière de 300 mm.

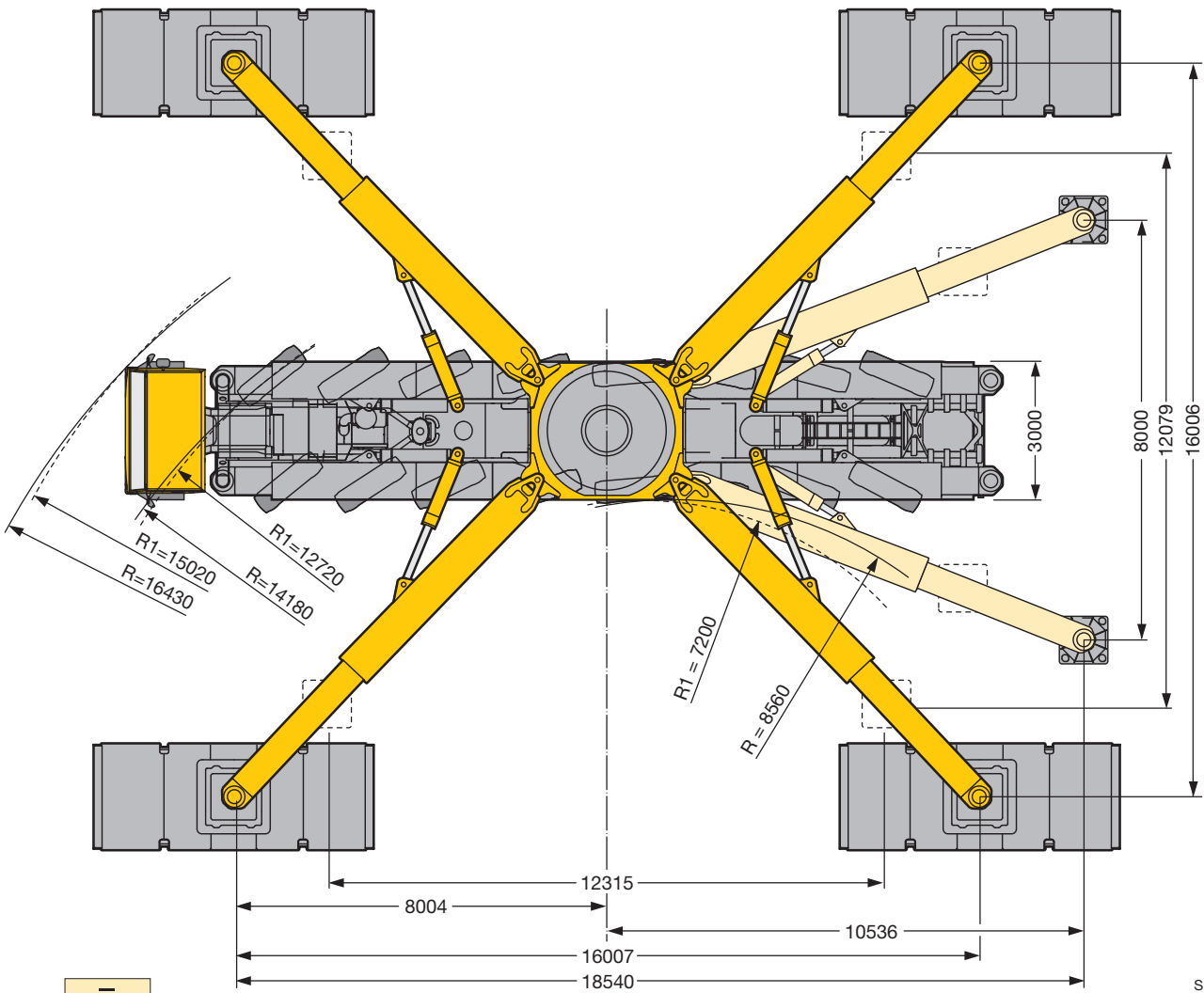

S1325.01



Achse Axle Essieu	1	2	3	4	5	6	7	8	Gesamtgewicht t Total weight t Poids total t
t	12	12	12	12	12	12	12	12	96

Maße Dimensions Encombrement

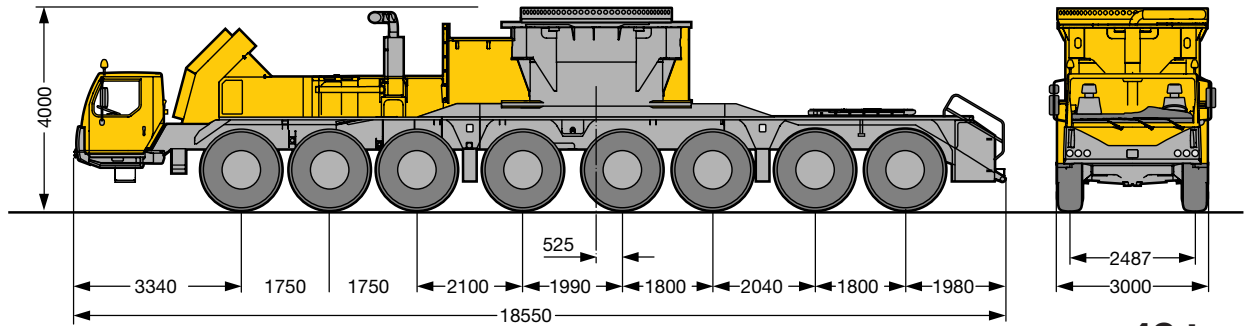

ca. 48 t

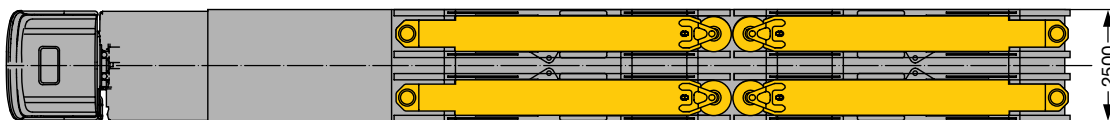
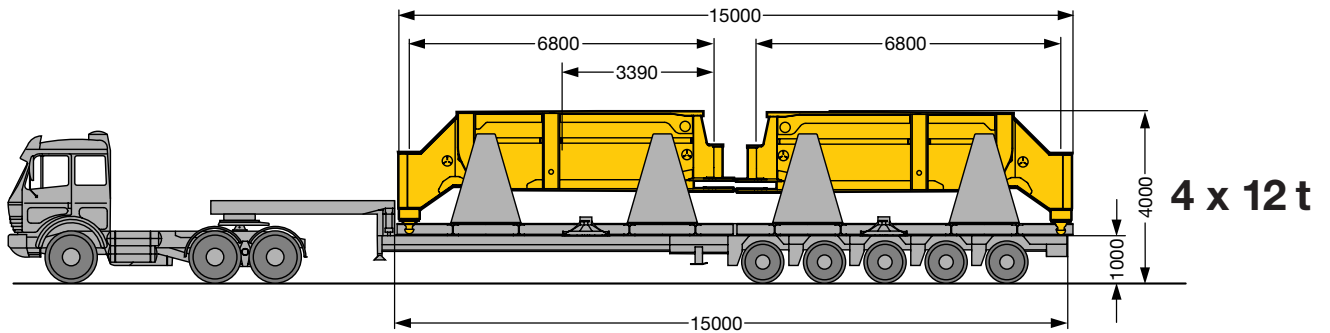
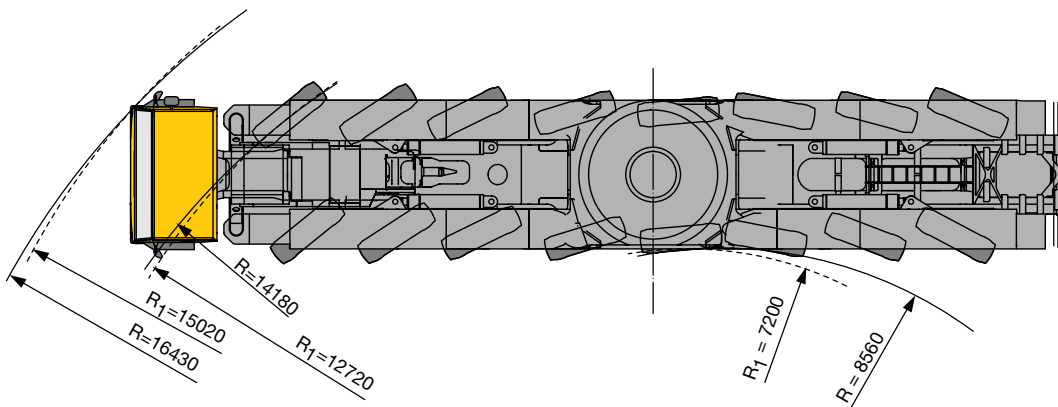

S1326



Achse Axle Essieu t	1	2	3	4	5	6	7	8	Gesamtgewicht t Total weight t Poids total t
	6,5	6,5	6,5	6,5	5,5	5,5	5,5	5,5	48

Transportplan Transportation plan Plan de transport

Drehbühne mit SA-Bock, Winde 4, Quick Connection, 2 Drehwerken
 Superstructure with SA-frame, winch 4, quick connection, 2 slewing gears
 Partie tournante avec chevalet SA, treuil 4, quick connection, 2 orientations

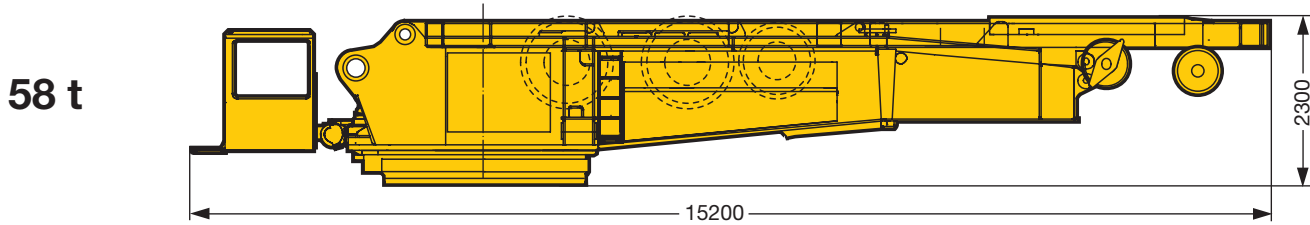

Drehbühne mit Quick Connection
 Superstructure with quick connection
 Partie tournante avec quick connection

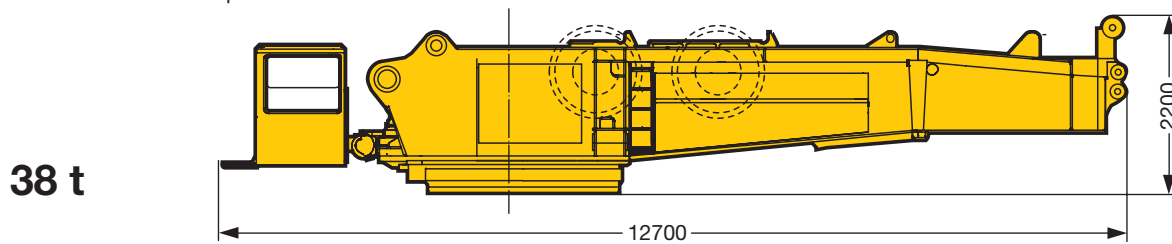

SA-Bock, Winde 4 inkl. Seil und Rollensatz
 SA-frame, winch 4 incl. rope and pulley block
 Chevalet SA, treuil 4 incl. câble et bloc de poulies

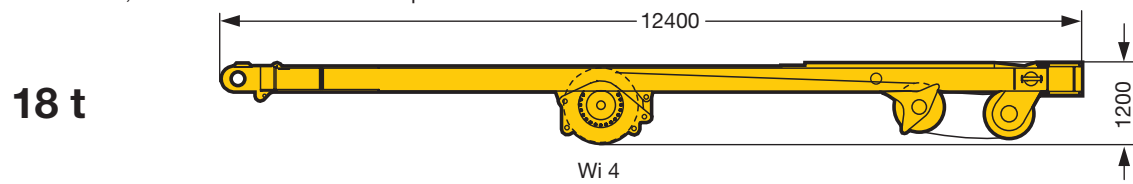

Winde 1 inkl. Seil
 Winch 1 incl. rope
 Treuil 1 incl. câble

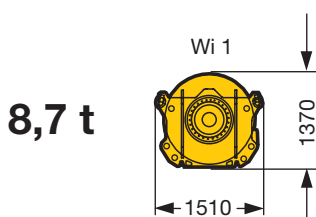

Winde 2 inkl. Seil
 Winch 2 incl. rope
 Treuil 2 incl. câble

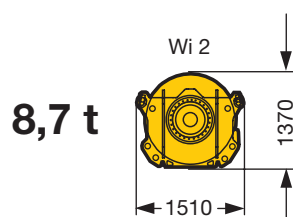

Matratze
 Crane mat
 Mat

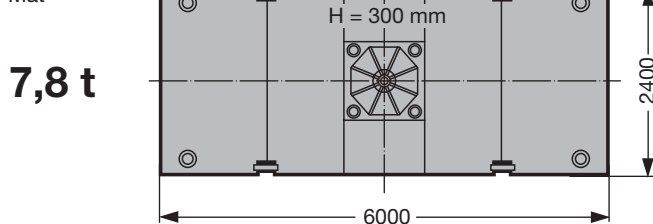

QC = Quick Connection
 Wi = Winde/winch/treuil

S1334

Transportplan Transportation plan Plan de transport

Ballastvarianten
Counterweight versions
Variantes de contrepoids

Drehbühnenballast
CWT at superstructure
Contrepoids - tourelle

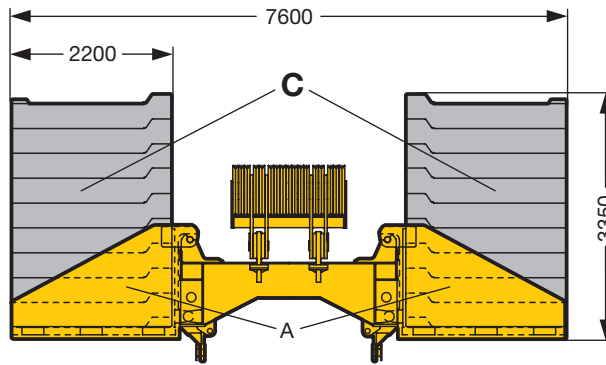

Teil A, Part A

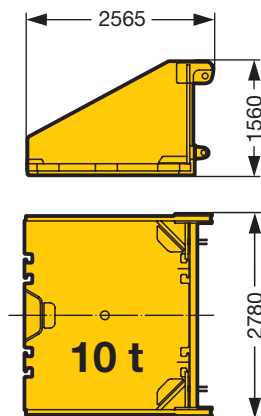

Teil C, Part C

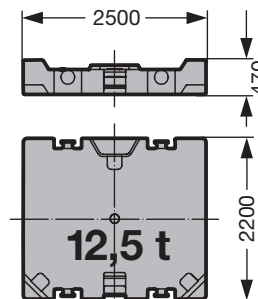

Mit Drehbühnenverlängerung
With extension of the superstructure
Avec extension de la tourelle

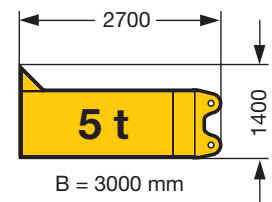

Mit Drehbühnenverlängerung With extension of the superstructure Avec extension de la tourelle	Ohne Drehbühnenverlängerung Without extension of the superstructure Sans extension de la tourelle
-	20 t
50 t	45 t
75 t	70 t
100 t	95 t
125 t	120 t
150 t	145 t
175 t	170 t
200 t	195 t
225 t	220 t
250 t	245 t

S1333

Aufbau Assembly Assemblage

Hilfskran abstützen
Tieflader mit Drehbühne rechtwinklig zum Kran anfahren
Drehbühne am Hilfskran anhängen

Set stand-by crane onto outriggers
Drive low loader with superstructure at right angle
towards the crane
Sling superstructure at the stand-by crane

Caler la grue auxiliaire
Approcher le semi-remorque transportant la partie
tournante perpendiculairement à la grue
Accrocher la partie tournante à la grue auxiliaire

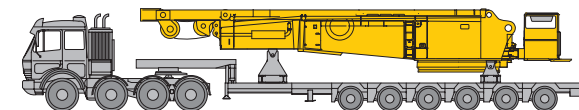

ca. 56 t

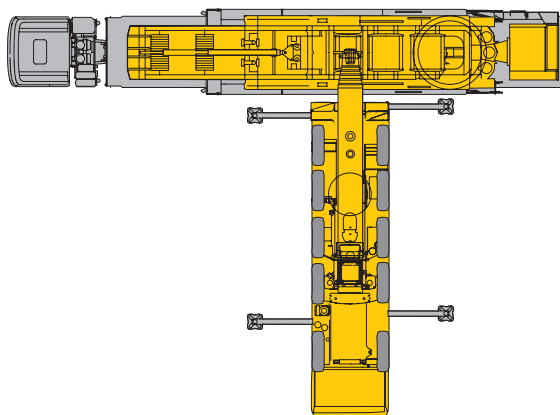

Drehbühne anheben
Tieflader unter der Drehbühne herausfahren

Lift the superstructure
Remove low loader from underneath the superstructure

Soulever la partie tournante
Eloigner le semi-remorque de manière
à libérer la partie tournante

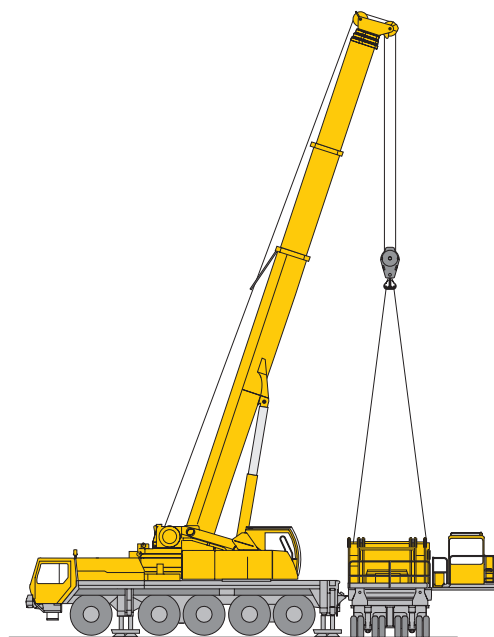
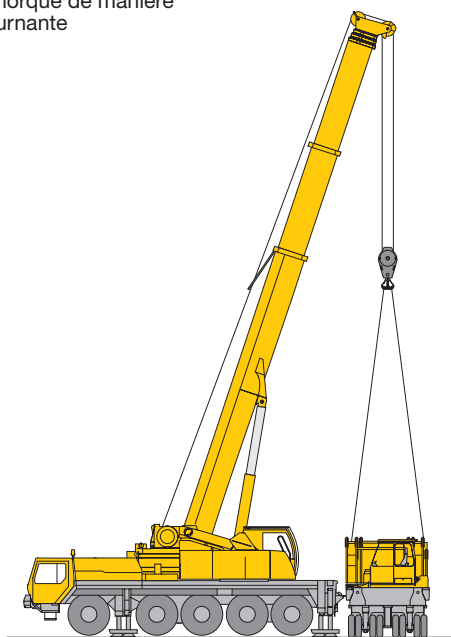

S1327

Aufbau Assembly Assemblage

LG 1750 im rechten Winkel zum Hilfskran unter die hängende Drehbühne fahren
 LG 1750 abstützen

Drive the LG 1750 at right angle to the stand-by crane under the suspended superstructure
 Set the LG 1750 onto outriggers

Positionner la LG 1750 sous la partie tournante suspendue, perpendiculairement à la grue auxiliaire
 Caler la LG 1750

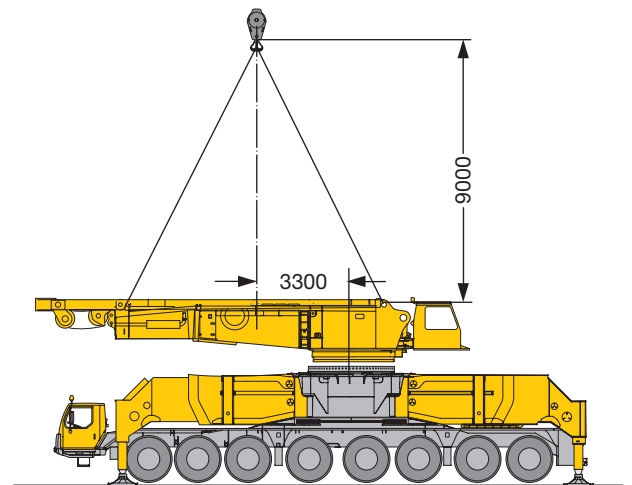
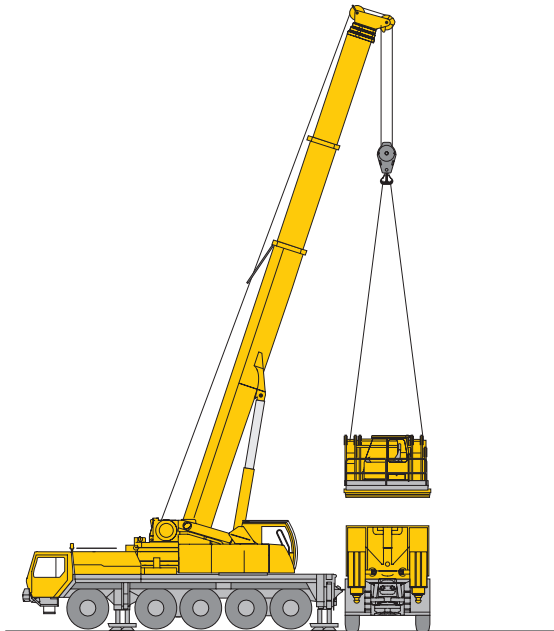

Drehbühne auf dem Fahrzeug aufsetzen

Position superstructure onto the carrier

Poser la partie tournante sur le véhicule

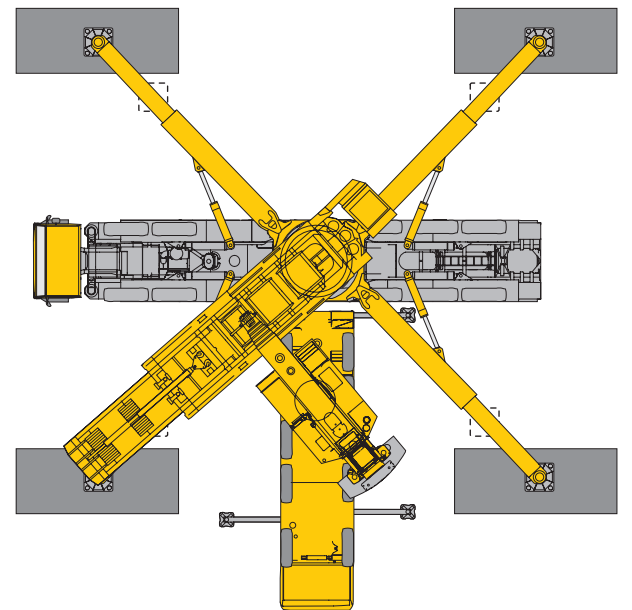
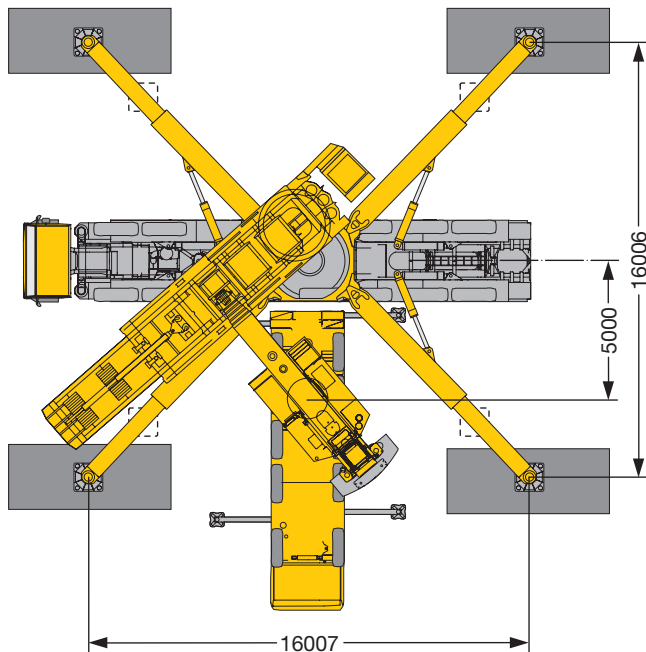

S1328

Aufbau Assembly Assemblage

Hilfskran versetzen
Laufstege anbauen, Winden einbauen, Ballast auflegen

Displace the stand-by crane
Fit catwalks, install winches, mount counterweight

Déplacer la grue auxiliaire
Installer la passerelle, monter les treuils et poser le contre poids

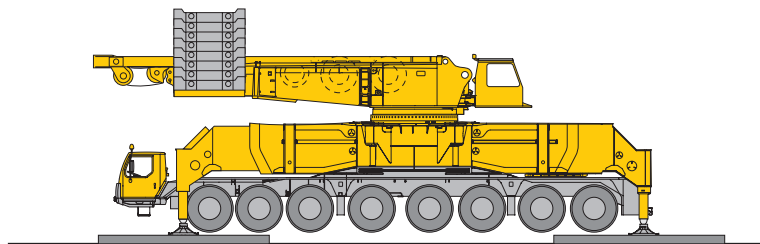
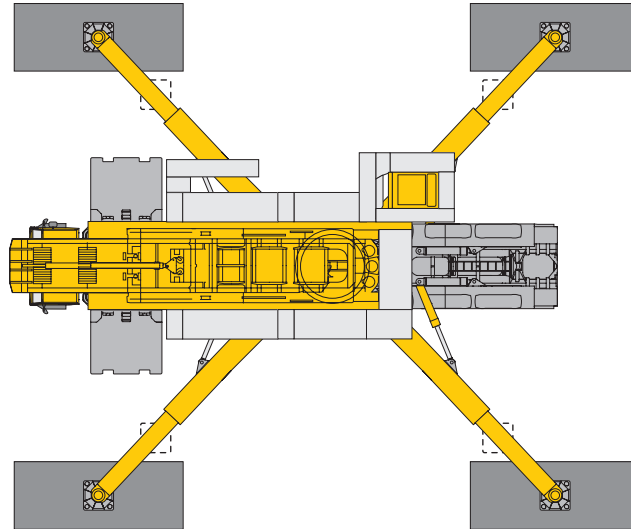

S1329

**Maße
Dimensions
Encombremet**

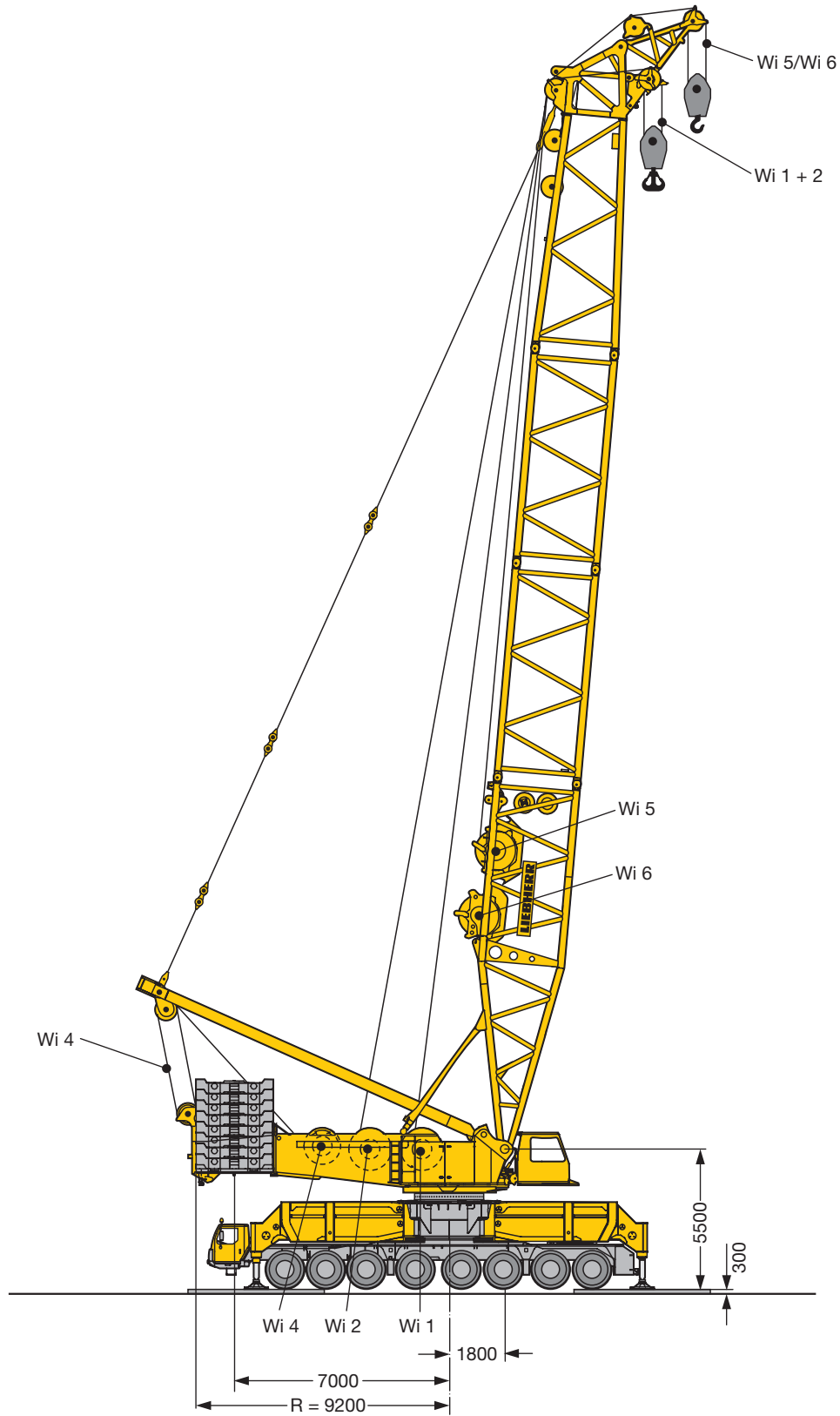

S1576

**Maße
Dimensions
Encombrement**

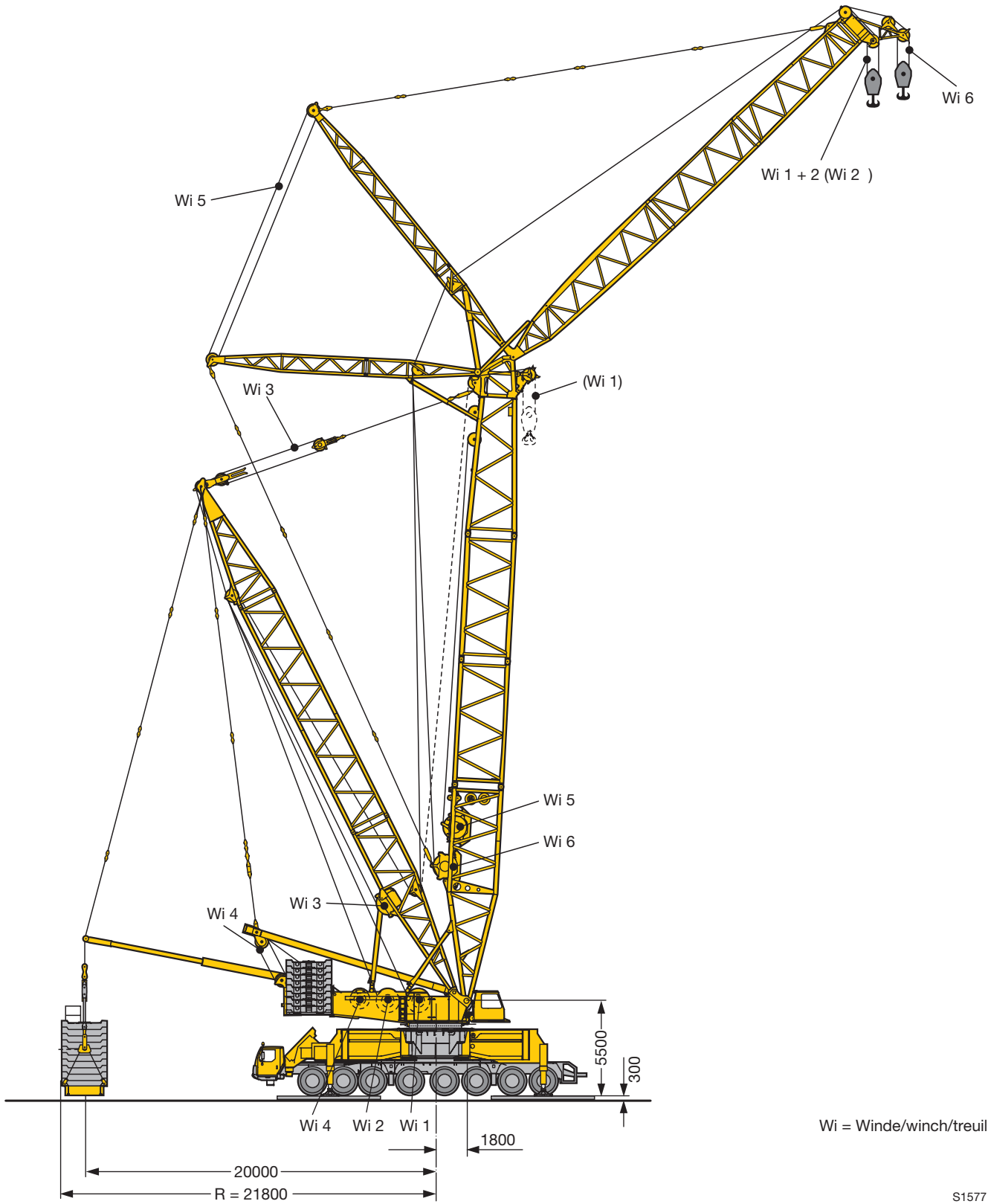

S1577

Geschwindigkeiten Working speeds Vitesses



		1	2	3	4	5	6	7	8	9	10	11	12	R 1	R 2	
505/95 R 25 (18.00 R 25)	km/h	6,3	8	10,4	13,3	16,8	21,6	28,6	36,6	47,4	60,7	76,9	80	6,8	8,7	33%



Antriebe Drive Mécanismes	Zuordnung Mode Mode	Geschwindigkeiten Speeds Vitesses m/min	Max. Seilzug Max. single line pull Effort au brin maxi. kN	Seil ø Rope diameter Diamètre du câble mm	Seillänge Rope length Longueur du câble m
	Hubwerk Hoist gear Mécanisme de levage	0 – 130	160	28	1250
	Hubwerk Hoist gear Mécanisme de levage	0 – 130	160	28	1250
	Verstellung Hauptausleger / D-Betrieb Derricking main boom / D-operation Relevage mât principale / en version D	0 – 130	160	28	1300
	Einziehwerk Derrick main boom Relevage mât principale	2 x 0 – 70	2 x 160	28	750
	Verstellung wippbare Gitterspitze Derricking luffing fly jib Relevage volée variable	0 – 130	160	28	1300
	Zusatzhubwinde Auxiliary hoist gear Trebil auxiliaire	0 – 130	160	28	600
	0 – 87°	ca. 4 min. bei 49 m Auslegerlänge approx. 4 min. for boom length 49 m env. 4 min. pour longueur de flèche de 49 m			
		0 – 1,5 min ⁻¹			

Lastaufnahmemittel Hooks blocks and hooks Organes de préhension



Traglasten (t) Load (t) Forces de levage (t)	Rollen No. of sheaves Poulies	Stränge No. of lines Brins	Gewicht (t) Weight (t) Poids (t)	Maß A (m) Dimension A (m) Dimension A (m)
600 / 300	2 x 11 / 1 x 11	2 x 22 / 1 x 23	11 - 16 / 8,4	5,3
400 / 200	2 x 7 / 1 x 7	2 x 14 / 1 x 15	7 - 15 / 5,5 - 7,5	4,6
107	3	7	2,5 - 5,5	4,5
47	1	3	1 - 3	4,2
16	-	1	1,1	3,2

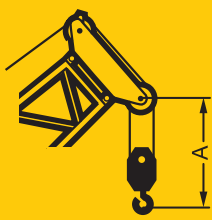

Einscherplan Reeving chart Tableau de mouflage

Stränge No. of lines Brins	1	2	3	4	5	6	7	8	9	10	11	12	13	14	15	16	17	18	19	20	21	22	23
Max. Traglast t Max. capacity t Capacité maxi. t	16	32	47	62	78	92	107	121	135	149	162	176	189	202	215	228	240	253	265	277	289	300	312
16 t																							
47 t																							
107 t																							
200 t																							
300 t																							



Stränge No. of lines Brins	2 x 4	2 x 5	2 x 6	2 x 7	2 x 8	2 x 9	2 x 10	2 x 11	2 x 12	2 x 13	2 x 14	2 x 15	2 x 16	2 x 17	2 x 18	2 x 19	2 x 20	2 x 21	2 x 22
Max. Traglast t Max. capacity t Capacité maxi. t	124	156	184	214	242	270	298	324	352	378	404	430	456	480	506	530	554	578	600
400 t																			
600 t																			



Transportplan Transportation plan Plan de transport

Ausleger-Zwischenstücke Boom intermediate sections Éléments de flèches intermédiaires	B x H	Grundlänge Base length Longueur de base	Transportlänge Transport length Longueur de transport	Gewicht* Weight* Poids*
S 2826.20	3 m x 3 m	7 m	7,4 m	6,7 t
		14 m	14,4 m	12,4 t
LA 2826.10	3 m x 3 m	7 m	7,4 m	4,5 t
		14 m	14,4 m	8,1 t
LI 2421.10	2,6 m x 2,4 m	7 m	7,4 m	3,7 t
		14 m	14,4 m	6,8 t
LI 2421.8	2,6 m x 2,4 m	7 m	7,4 m	3,0 t
		14 m	14,4 m	5,6 t
D 2421.10	2,6 m x 2,4 m	14 m	14,4 m	8,5 t

* Gewichte inkl. Abspannstangen und Bolzen / Weights incl. guy rods and bolts / Poids avec barres de haubanage et boulons

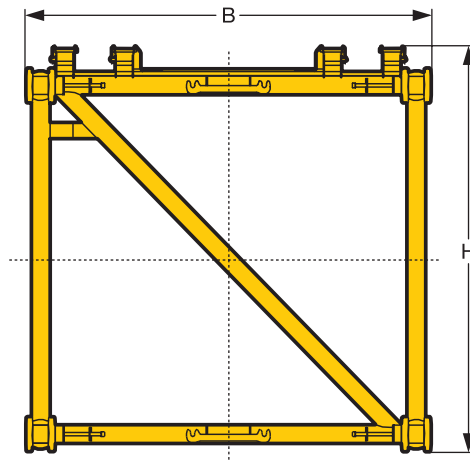

Auslegersysteme Boom/jib combinations Configurations de flèche

S Hauptausleger, schwer
Main boom, heavy
Flèche principale, lourde

SL Hauptausleger, schwer/leicht
Main boom, heavy/light
Flèche principale, lourde/légère

W Wippbare Gitterspitze, schwer
Luffing fly jib, heavy
Fléchette, lourde

D Derricksausleger
Derrick
Flèche derrick

B Schwebeballast
Suspended ballast
Lest suspendu

V Feste Gitterspitze, schwer
Lattice fly jib, heavy
Fléchette treillis fixe, lourde

K Knickausleger
Articulated main boom
Flèche à montage articulé



SL

SL 28 m – 105 m

**SLD
SLDB**

SL 35 m – 133 m
D 31,5 m

S

S 21 m – 84 m

**SD
SDB**

S 35 m – 140 m
D 31,5 m

SW

S 35 m – 63 m
W 28 m – 105 m

Auslegersysteme Boom/jib combinations Configurations de flèche

■ 400 t / 600 t S-Kopf / S-Head / S-Tête
■ 400 t L-Kopf / L-Head / L-Tête

■ S - System 2826.20
■ S - System 2826.30
■ F - System
■ LA - System 2826.10
■ LI - System 2421.10
■ LI - System 2421.8
■ D - System 2421.10

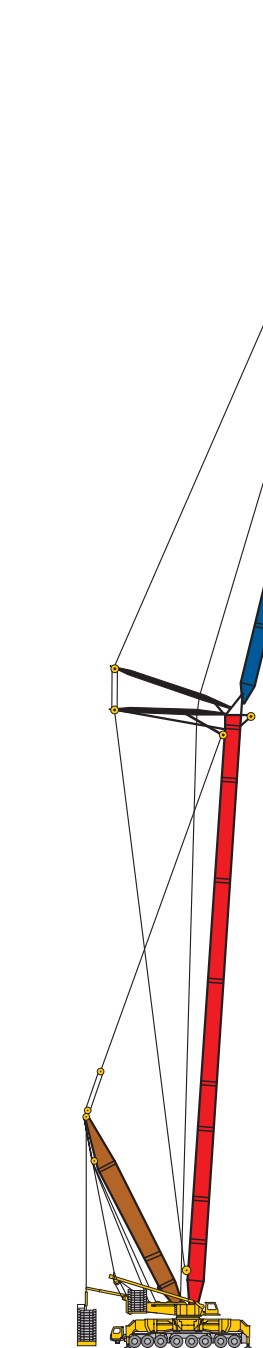

SDWB

S 35 m – 91 m
 W 28 m – 105 m
 D 31,5 m

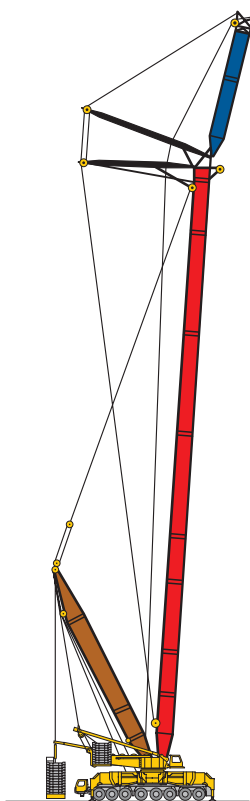

**SDWV
SDWVB**

S 35 m – 91 m
 W 14 m – 21 m
 D 31,5 m

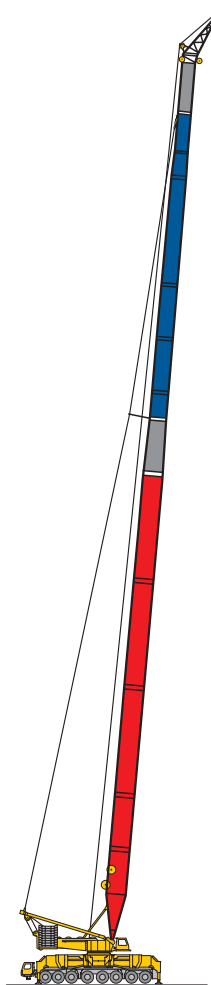

SL8HS

SL 70 m – 115 m
 HS 6 m

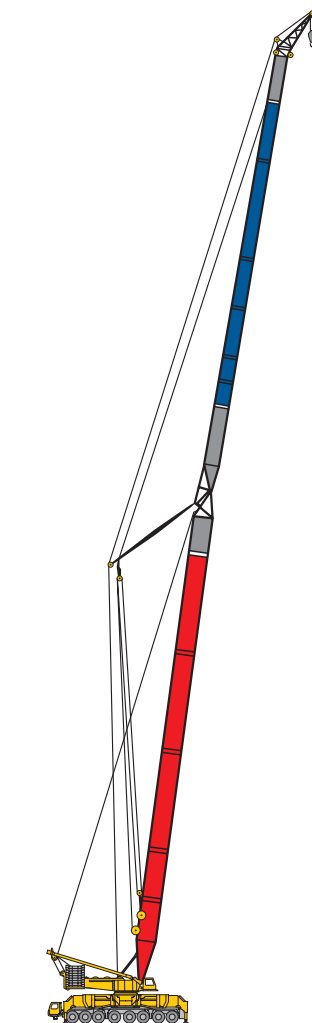

SLK

SLK 108,5 m – 133 m

S1914

Traglasten am S-Auslegersystem

Lifting capacities on S boom

Forces de levage en configuration S

S

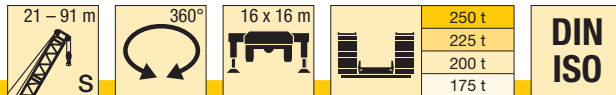

	21 m	28 m	35 m	42 m	49 m	56 m	63 m	70 m	77 m	84 m	91 m	
6	596											6
6,5	571	573										6,5
7	547	550	546									7
8	506	508	504	501	497							8
9	475	472	468	465	461	458						9
10	443	440	436	433	430	427	424	411				10
11	416	412	409	406	402	399	397	394	347	295		11
12	383	381	378	376	373	371	369	368	343	291	250	12
14	328	326	323	321	318	316	314	313	308	284	244	14
16	283	281	279	277	274	272	271	269	268	260	237	16
18	240	246	244	242	239	237	235	234	233	230	221	18
20	186	218	216	214	211	209	208	206	205	204	198	20
22		196	193	191	189	187	185	183	182	181	178	22
24		171	175	173	170	168	166	165	163	162	160	24
26		144	159	157	154	152	150	149	148	146	145	26
28			144	144	141	139	137	135	134	133	131	28
30			126	132	129	127	125	124	122	121	120	30
32			110	121	119	117	115	114	112	111	109	32
34				109	111	108	107	105	103	102	100	34
36				97	101	101	99	97	96	94	90	36
38				86	92	93	91	90	88	87	83	38
40				74	83	85	84	83	82	80	77	40
44					66	71	71	70	68	67	65	44
48						58	60	59	58	56	55	48
52						45,5	49	49,5	49	47	45	52
56							39,5	41	41	40	37,5	56
60								32,5	33,5	33,5	31,5	60
64								25	26,5	27,1	26,3	64
68									20	21,3	21,2	68
72									13,5	15,8	16,4	72
76										10,6	11,9	76
80											7,6	80

TAB 154030 / 154031 / 154032 / 154033

Hubhöhen am S-Auslegersystem
Lifting heights on S boom
Hauteur de levage en configuration S

S

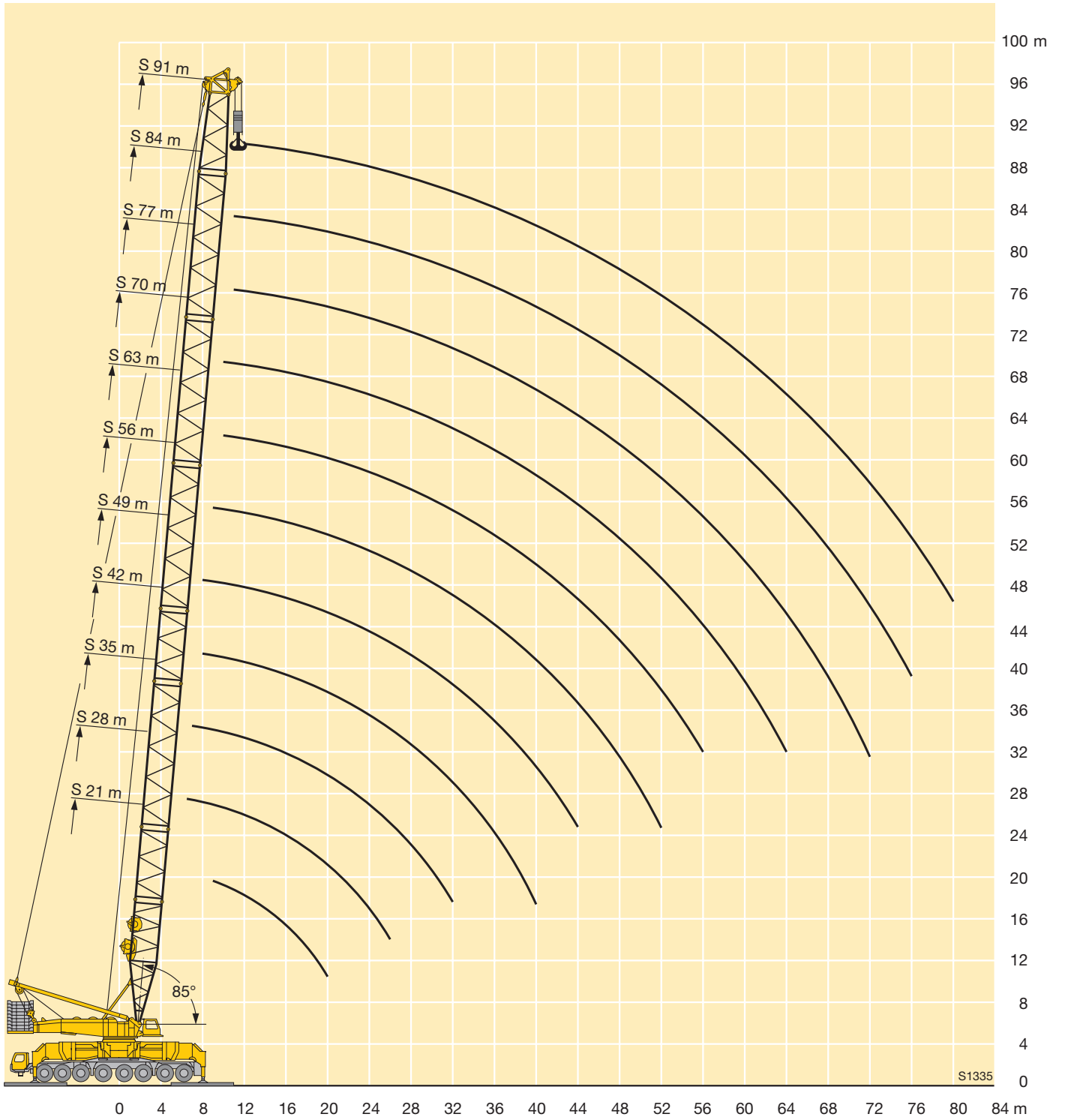

Traglasten am S-Auslegersystem

Lifting capacities on S boom

Forces de levage en configuration S

S

m	21 - 91 m		360°	12 x 12 m	245 t 220 t 195 t 170 t	DIN ISO	m											
	21 m	28 m					35 m	42 m	49 m	56 m	63 m	70 m	77 m	84 m	91 m	m		
6	670															6		
6,5	621	619														6,5		
7	579	577	574													7		
8	510	507	505	503	500											8		
9	455	452	450	448	445	442										9		
10	410	408	405	403	400	398	396	383								10		
11	373	371	368	366	363	361	359	344	326	295						11		
12	342	340	337	335	332	330	328	311	296	281	242					12		
14	289	287	285	283	280	278	274	260	249	237	227					14		
16	248	247	244	242	240	238	233	222	213	204	195					16		
18	217	216	213	211	209	207	201	192	185	177	170					18		
20	186	191	189	187	184	182	176	169	162	156	150					20		
22		171	169	167	164	162	156	149	144	138	133					22		
24		155	152	150	147	145	139	133	128	123	118					24		
26		141	138	136	134	131	125	120	115	111	106					26		
28			126	124	122	118	113	108	104	100	96					28		
30			114	112	110	108	103	98	94	90	86					30		
32			103	102	100	98	94	89	86	82	78					32		
34				93	90	89	86	81	78	74	71					34		
36				85	83	81	79	75	71	68	65					36		
38				78	76	74	72	69	65	62	59					38		
40				73	70	68	66	63	60	57	54					40		
44					60	58	56	54	51	47,5	44,5					44		
48						50	48	46	43	40	37					48		
52						43,5	41,5	39,5	36,5	33,5	31					52		
56							35,5	33,5	31	28,3	25,4					56		
60								28,4	26,4	23,6	20,7					60		
64								24,3	22	19,6	16,7					64		
68									18,3	16,2	13,2					68		
72									13,5	13	10,1					72		
76										10,1	7,4					76		
80											5,1					80		

TAB 154001 / 154002 / 154003 / 154004

Hubhöhen am S-Auslegersystem
Lifting heights on S boom
Hauteur de levage en configuration S

S

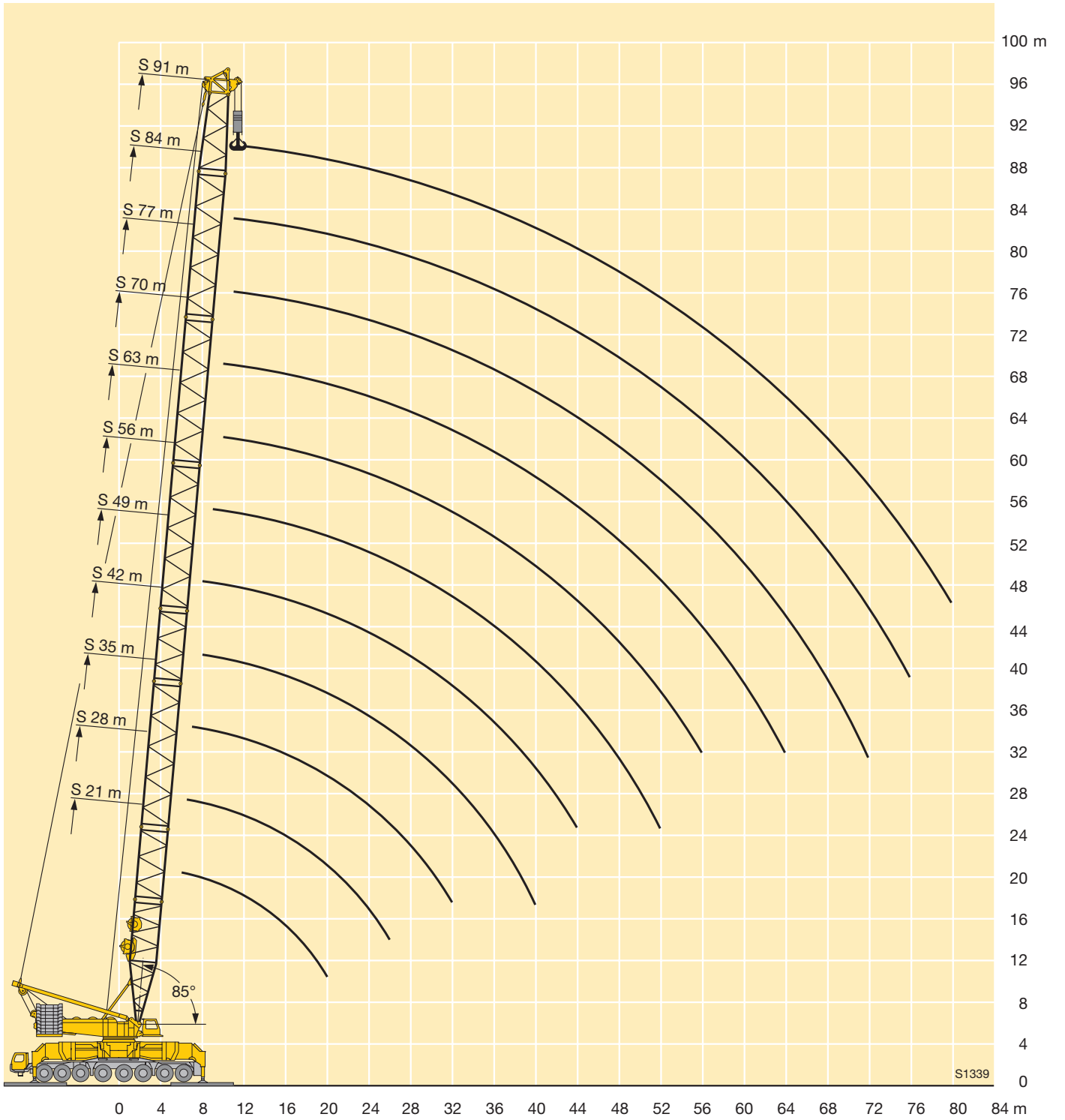

Traglasten am SL-Auslegersystem

Lifting capacities on SL boom

Forces de levage en configuration SL

SL



	28 m	35 m	42 m	49 m	56 m	63 m	70 m	77 m	84 m	91 m	98 m	105 m	
6	400												6
6,5	400												6,5
7	400	400											7
8	400	400	400	400									8
9	400	400	400	400	400	385							9
10	400	400	400	400	400	382	358	300					10
11	400	400	400	400	400	379	356	300	281				11
12	387	384	383	381	379	377	354	292	276	223	210		12
14	331	329	328	326	324	322	320	283	265	217	206	166	14
16	287	285	284	282	280	278	276	273	254	211	201	163	16
18	252	250	249	247	245	243	241	240	238	205	195	159	18
20	224	222	221	219	217	215	214	213	211	198	187	154	20
22	201	200	198	196	195	193	191	190	188	188	179	150	22
24	177	181	180	178	176	174	172	171	169	169	167	145	24
26	150	165	164	162	160	158	156	156	154	153	151	141	26
28		151	151	149	147	145	143	142	140	140	138	137	28
30		133	139	137	135	133	131	130	129	128	126	126	30
32		117	129	127	125	123	121	120	118	118	116	116	32
34			117	118	116	114	113	112	110	109	107	107	34
36			105	110	109	106	105	104	102	101	99	99	36
38			94	101	102	99	98	97	95	94	92	92	38
40			81	92	95	93	91	90	88	88	86	85	40
44				75	81	81	80	79	77	77	74	74	44
48					67	70	70	69	67	67	64	64	48
52					55	59	60	60	58	58	56	56	52
56						49	51	52	51	50	48	48	56
60							43	44,5	44	44	41,5	41,5	60
64							35	37,5	37,5	38	36	36	64
68								31	31,5	32,5	31	31,5	68
72								23,8	25,9	27,6	26,6	27,1	72
76									20,5	22,7	22,3	23,1	76
80										18,1	18,1	19,3	80
84											14,2	15,7	84
88											10,4	12,3	88
92												9	92
96												6	96

TAB 154106 / 154108 / 154110 / 154112

Hubhöhen am SL-Auslegersystem
Lifting heights on SL boom
Hauteur de levage en configuration SL

SL

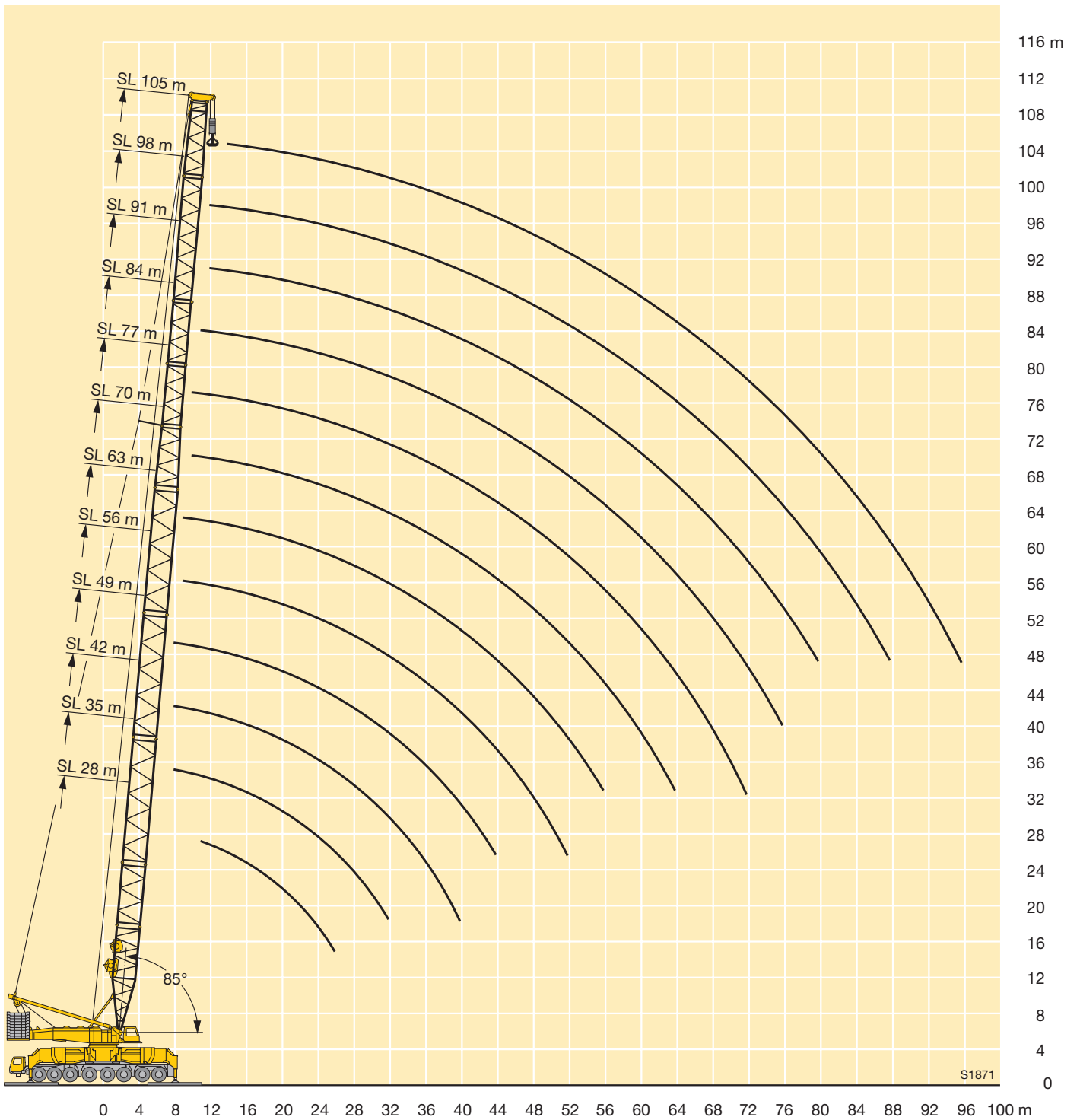

Traglasten am SL-Auslegersystem

Lifting capacities on SL boom

Forces de levage en configuration SL

SL

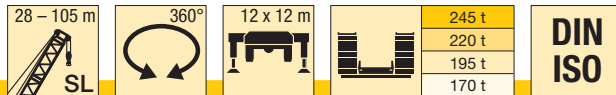

	28 m	35 m	42 m	49 m	56 m	63 m	70 m	77 m	84 m	91 m	98 m	105 m	
6	400												6
6,5	400												6,5
7	400	400											7
8	400	400	400	400									8
9	400	400	400	400	400	385							9
10	400	400	400	400	400	382	358	300					10
11	376	374	373	370	368	366	355	300	281				11
12	345	343	342	339	337	335	322	292	276	223	210		12
14	293	291	290	288	286	284	271	259	247	217	206	166	14
16	252	250	249	247	246	244	233	223	213	205	196	163	16
18	221	219	218	216	214	212	203	195	187	181	172	159	18
20	197	195	194	192	190	187	179	173	165	160	153	149	20
22	177	175	174	172	170	167	160	154	148	143	137	133	22
24	160	158	157	155	153	150	144	139	133	129	123	120	24
26	146	144	143	141	139	136	130	126	120	117	111	109	26
28		132	131	129	128	124	119	114	109	107	101	99	28
30		119	119	117	116	113	108	105	100	97	92	90	30
32		109	108	107	106	104	100	96	92	89	85	83	32
34			99	98	96	95	92	89	84	82	78	76	34
36			92	90	88	87	85	82	78	76	71	70	36
38			85	83	82	80	79	76	72	70	66	65	38
40			79	77	76	74	72	71	67	65	61	60	40
44				67	65	64	62	61	58	56	52	51	44
48					57	55	54	53	50	48,5	44,5	43,5	48
52					51	48,5	47	46	43,5	42	38,5	37,5	52
56						43	41,5	40,5	38,5	36,5	33	32,5	56
60							36,5	35,5	33	32	28,5	27,7	60
64							32,5	31	28,8	28,1	24,5	23,6	64
68								27,3	24,9	24,3	21	20,1	68
72								23,8	21,6	20,9	18	17	72
76									18,7	17,9	15,3	14,2	76
80										15,3	12,8	11,7	80
84											10,5	9,5	84
88											8,4	7,6	88
92												5,7	92
96												4	96

TAB 154077 / 154078 / 154079 / 154080

Hubhöhen am SL-Auslegersystem
Lifting heights on SL boom
Hauteur de levage en configuration SL

SL

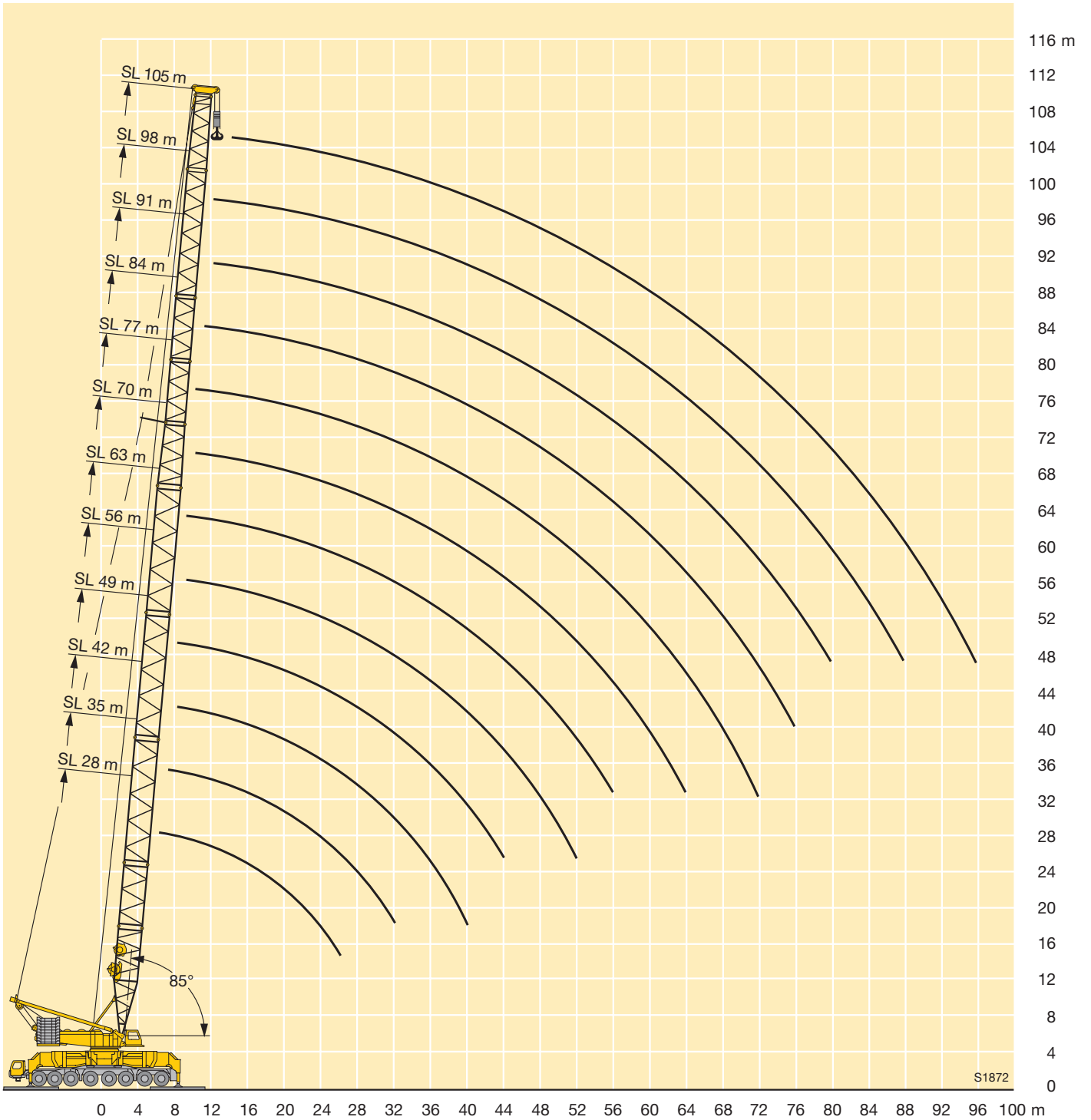

Traglasten am SL8HS-Auslegersystem

Lifting capacities on SL8HS boom

Forces de levage en configuration SL8HS

SL8HS

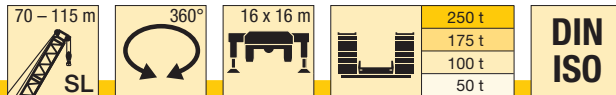

m	70 m	77 m	84 m	91 m	98 m	105 m	112 m	115 m	m
	6 m	6 m	6 m	6 m	6 m	6 m	6 m	6 m	
14	120	120	120						14
16	118	120	120	120	120	120			16
18	110	113	114	117	114	115	109	101	18
20	103	106	108	110	109	110	105	98	20
22	96	100	102	105	104	105	102	95	22
24	91	94	96	99	99	101	98	91	24
26	85	89	91	95	95	97	94	88	26
28	81	85	87	90	90	93	91	85	28
30	77	81	83	86	87	89	88	83	30
32	73	77	79	83	83	86	85	80	32
34	70	73	76	79	80	83	82	78	34
36	67	70	73	76	77	80	79	76	36
38	64	67	70	73	74	77	77	73	38
40	61	65	67	71	72	74	74	71	40
44	56	60	63	66	67	69	69	67	44
48	52	56	58	62	63	63	61	60	48
52	49	52	55	58	58	55	54	52	52
56	46	49	51	52	51	49	47,5	46,5	56
60	43,5	46	47	45,5	45	43,5	42	41	60
64	41	41,5	41,5	40,5	39,5	38	37	36	64
68	35,5	36	36,5	35	35	33,5	32	31,5	68
72		31	32	30,5	30,5	29,1	28	27,1	72
76			27,4	26,5	26,5	25,1	24,2	23,3	76
80			23,2	22,6	22,7	21,4	20,6	19,8	80
84				18,9	19,3	18,1	17,3	16,5	84
88					15,9	15,1	14,4	13,6	88
92					12,8	12,2	11,8	11,1	92
96						9,4	9,4	8,8	96
100							7	6,6	100
104							4,7	4,5	104
108								2,4	108

TAB 154374 / 154377 / 154380 / 154382

Hubhöhen am SL8HS-Auslegersystem
Lifting heights on SL8HS boom
Hauteur de levage en configuration SL8HS

SL8HS

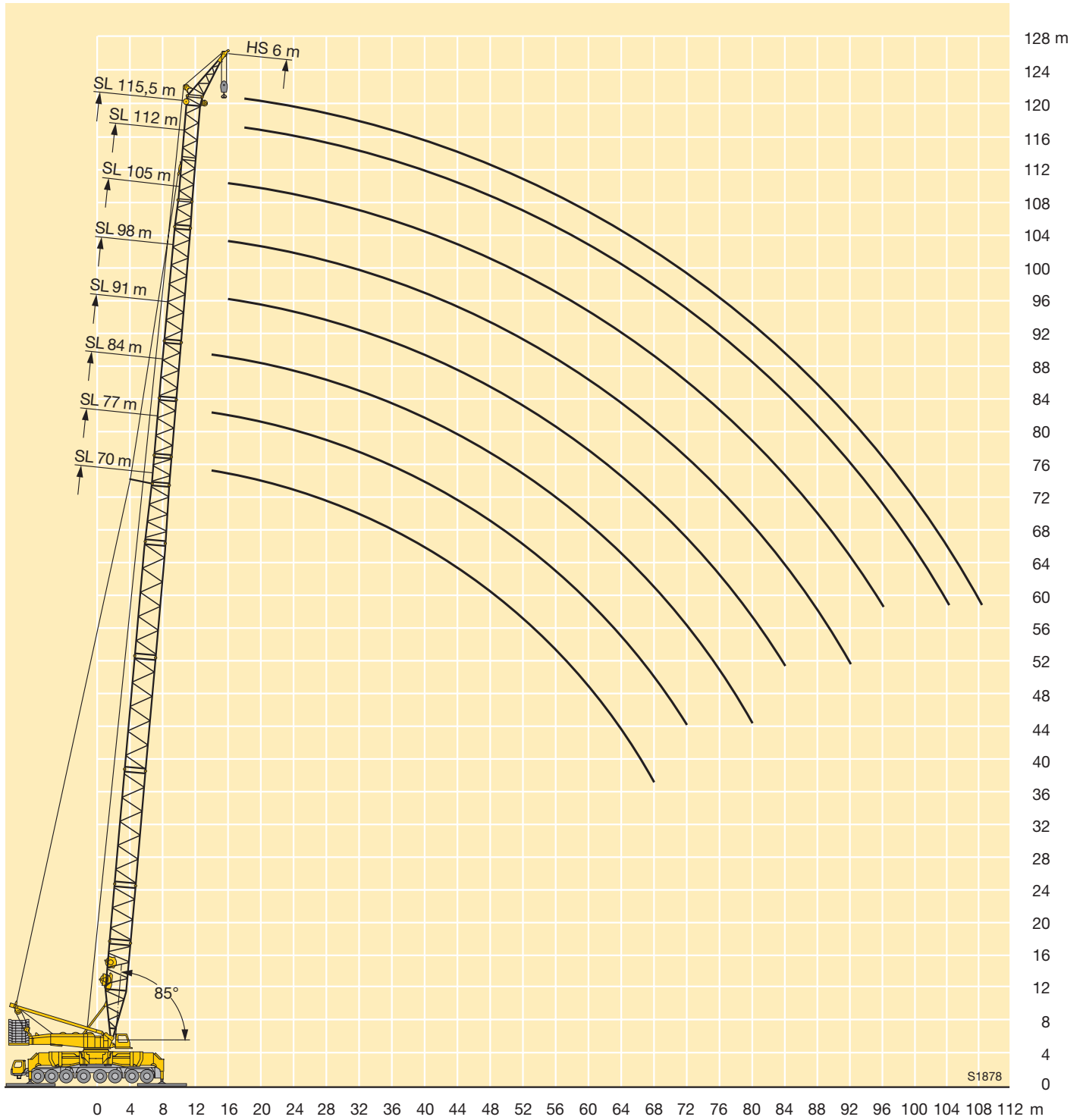

S1878

Traglasten am SL8HS-Auslegersystem
Lifting capacities on SL8HS boom
Forces de levage en configuration SL8HS

SL8HS

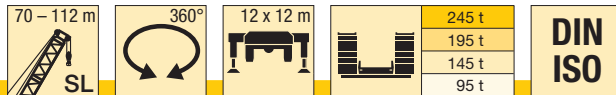

m	70 m	77 m	84 m	91 m	98 m	105 m	112 m	m
	6 m	6 m	6 m	6 m	6 m	6 m	6 m	
14	120	120	120					14
16	118	120	120	120	120	120		16
18	110	113	114	117	114	115	109	18
20	103	106	108	110	109	110	105	20
22	96	100	102	105	104	105	102	22
24	91	94	96	99	99	101	98	24
26	85	89	91	95	95	97	94	26
28	81	85	87	90	90	93	91	28
30	77	81	83	86	87	89	87	30
32	73	77	79	83	83	83	80	32
34	70	73	76	79	80	76	73	34
36	67	70	73	76	74	70	67	36
38	64	67	70	72	69	65	62	38
40	61	65	67	66	64	60	57	40
44	56	60	62	58	55	51	48,5	44
48	52	56	54	50	48	44,5	41,5	48
52	49	49	47,5	44	41,5	38	35,5	52
56	45	43,5	42	38,5	36	33	30,5	56
60	40	38,5	37	33,5	31,5	28,4	26	60
64	36	34	33	29,6	27,6	24,4	22,1	64
68	32,5	30,5	28,9	26,1	24,1	20,9	18,6	68
72		26,9	25,4	22,8	21	17,8	15,5	72
76			22,4	19,8	18,2	15	12,7	76
80			19,8	17,1	15,8	12,6	10,3	80
84				14,7	13,5	10,4	8,1	84
88					11,4	8,5	6,2	88
92					9,5	6,7	4,4	92
96						5,2	2,9	96

TAB 154354 / 154356 / 154358 / 154360

Hubhöhen am SL8HS-Auslegersystem
Lifting heights on SL8HS boom
Hauteur de levage en configuration SL8HS

SL8HS

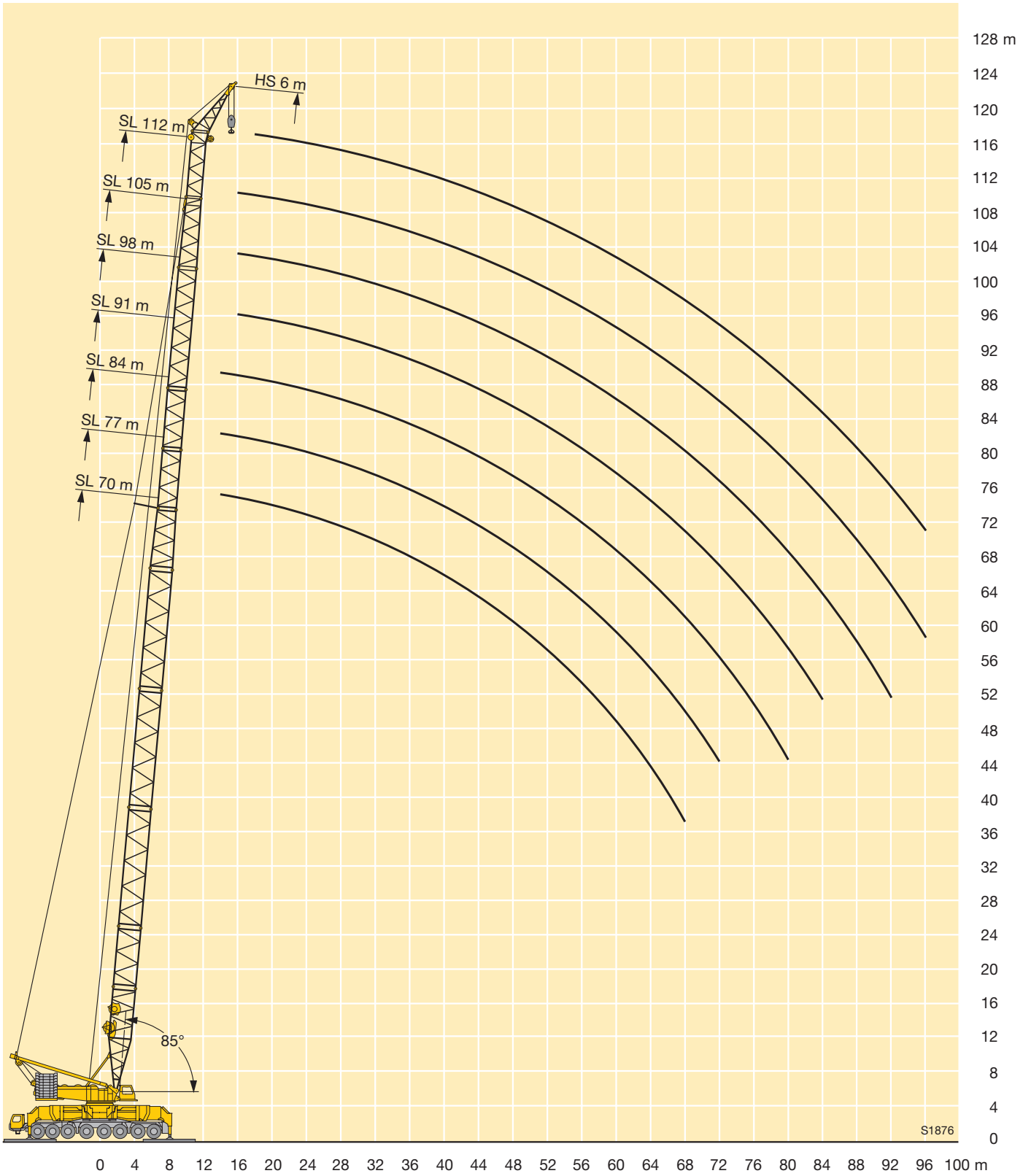

Traglasten am SLK-Auslegersystem

Lifting capacities on SLK boom

Forces de levage en configuration SLK

SLK

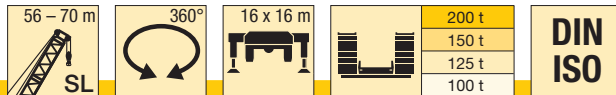

m	56 m		63 m		70 m			m
	52,5 m	59,5 m	52,5 m	59,5 m	52,5 m	59,5 m	63 m	
	6 m	6 m	6 m	6 m	6 m	6 m	6 m	
22	98		105		107			22
24	91	88	98	95	104	99		24
26	85	82	92	89	98	94	90	26
28	80	77	86	83	92	88	84	28
30	74	72	81	78	87	83	79	30
32	70	67	76	73	82	78	74	32
34	65	63	72	69	77	73	70	34
36	61	59	68	65	74	69	65	36
38	57	55	64	62	70	65	62	38
40	54	52	60	58	66	62	58	40
44	47,5	46	54	52	59	55	52	44
48	42,5	40,5	48	46,5	54	50	47	48
52	38	36	43	41	46	44,5	42,5	52
56		32	39	37	39,5	38	37	56
60				33,5	33	32	31,5	60
64						26,6	26,5	64
68							21,7	68

TAB 154383 / 154385 / 154386 / 154387

Hubhöhen am SLK-Auslegersystem
Lifting heights on SLK boom
Hauteur de levage en configuration SLK

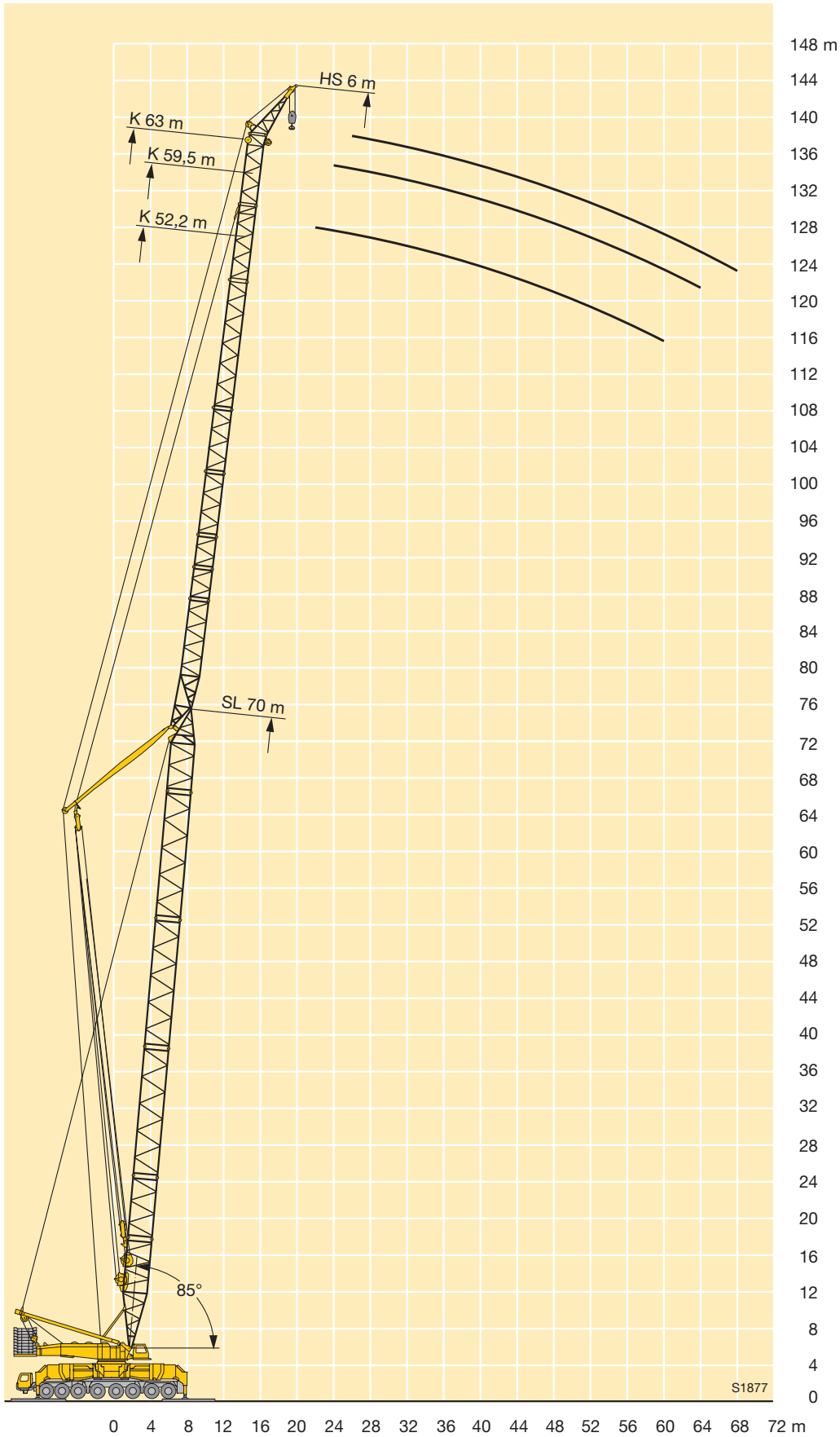

Traglasten am SLK-Auslegersystem

Lifting capacities on SLK boom

Forces de levage en configuration SLK

SLK

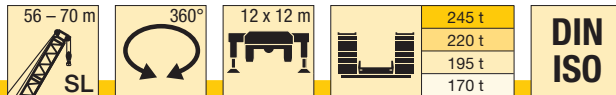

m	56 m		63 m		70 m			m
	52,5 m	59,5 m	52,5 m	59,5 m	52,5 m	59,5 m	63 m	
	6 m	6 m	6 m	6 m	6 m	6 m	6 m	
22	98		105		107			22
24	91	88	98	95	104	99		24
26	85	82	92	89	98	94	90	26
28	80	77	86	83	92	88	84	28
30	74	72	81	78	86	83	79	30
32	70	67	76	73	79	76	74	32
34	65	63	72	69	72	70	68	34
36	61	59	68	65	66	64	62	36
38	57	55	64	62	61	58	57	38
40	54	52	60	57	56	53	52	40
44	47,5	46	51	48,5	47	45	43,5	44
48	42,5	40,5	43,5	41,5	39,5	37,5	36,5	48
52	38	36	37	35	33,5	31,5	30,5	52
56		32	31,5	29,5	27,9	26,1	25	56
60				24,7	23,1	21,4	20,4	60
64						17,2	16,2	64
68							12,5	68

TAB 154434 / 154435 / 154436 / 154437

Hubhöhen am SLK-Auslegersystem
Lifting heights on SLK boom
Hauteur de levage en configuration SLK

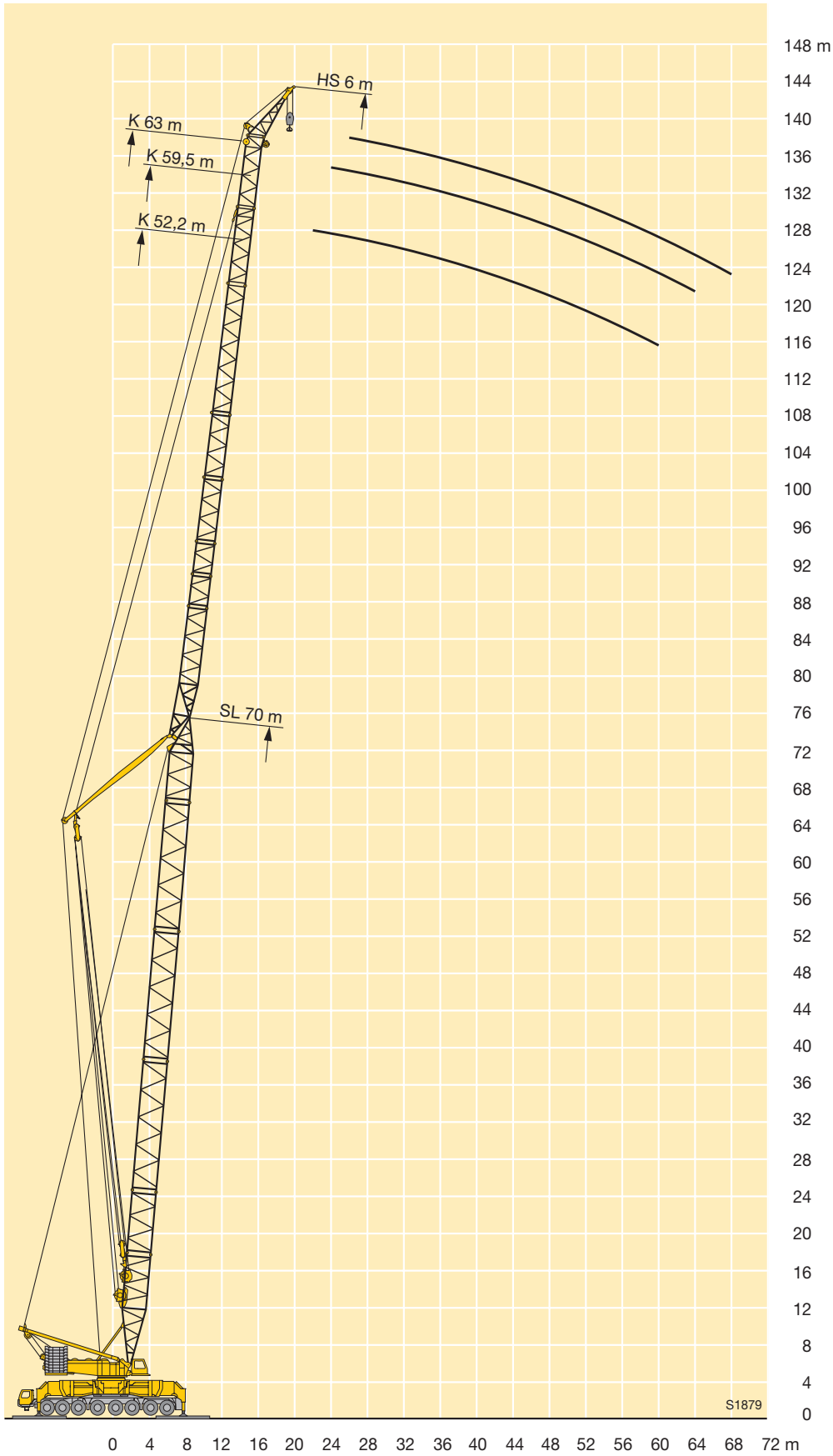

Traglasten am SD-Auslegersystem

Lifting capacities on SD boom/derrick combination

Forces de levage en configuration SD

SD

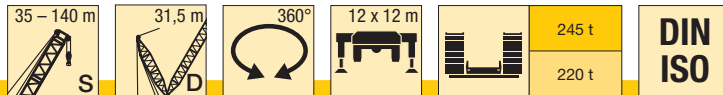

m	35 m	42 m	49 m	56 m	63 m	70 m	77 m	84 m	91 m	98 m	105 m	112 m	119 m	126 m	133 m	140 m	m
7	581																7
8	511	508	505														8
9	455	453	450	448													9
10	410	407	404	403	401	399											10
11	373	370	367	365	363	361	340	321									11
12	341	339	336	334	332	327	309	292	278	258							12
14	286	283	281	278	276	273	260	247	236	225	217	192	167				14
16	241	238	235	233	229	227	223	212	203	194	188	181	167	144	124	105	16
18	209	206	202	199	195	194	192	184	177	170	164	159	153	143	123	105	18
20	182	180	177	174	169	167	167	162	156	150	145	140	135	130	123	104	20
22	160	157	155	152	149	146	144	142	138	133	129	125	120	116	111	104	22
24	143	140	137	134	131	128	127	125	123	119	115	112	108	103	100	97	24
26	129	127	124	122	116	116	112	110	108	107	104	100	97	93	89	87	26
28	119	115	113	111	106	106	100	98	95	95	92	91	87	84	81	78	28
30	110	103	102	101	97	98	90	88	85	84	82	81	79	75	73	70	30
32	102	96	93	92	89	89	82	79	76	75	73	72	70	68	65	64	32
34		89	83	84	81	82	74	71	69	67	65	64	62	61	59	57	34
36		84	77	76	74	75	66	63	61	60	57	56	55	54	53	50	36
38		78	72	68	67	68	59	57	54	54	51	50	48,5	47,5	46	43,5	38
40		73	68	61	60	62	53	52	48	48	46	44	42,5	41,5	40	37,5	40
44			60	54	48	49,5	44,5	43	40	38	36	34,5	32	31	29,2	26,4	44
48				48	42,5	38,5	36,5	35	32,5	31	26,8	25,6	23,2	23	21,2	17,6	48
52				42,5	37,5	33	29,2	27,7	25,9	25,1	21,2	18,1	16,5	16,3	14,8	10,3	52
56					32,5	28,5	24,5	20,8	19,7	19,5	16,5	14,6	13,4	10,1	8,8	8	56
60						24,5	21	16,5	13,8	14,2	12,2	11,3	10,5	7,1	5,1	6	60
64						20,8	17,7	13,9	9,8	9,3	8,2	8,3	7,9	5,6	3,9	4,2	64
68							14,6	11,4	7,8	5,6	4,4	5,4	5,3	4,2			68
72							11,7	9,1	6	4,6			3				72
76								6,9	4,2	3,6							76

TAB 154153 / 154154

Hubhöhen am SD-Auslegersystem
Lifting heights on SD boom/derrick combination
Hauteur de levage en configuration SD

SD

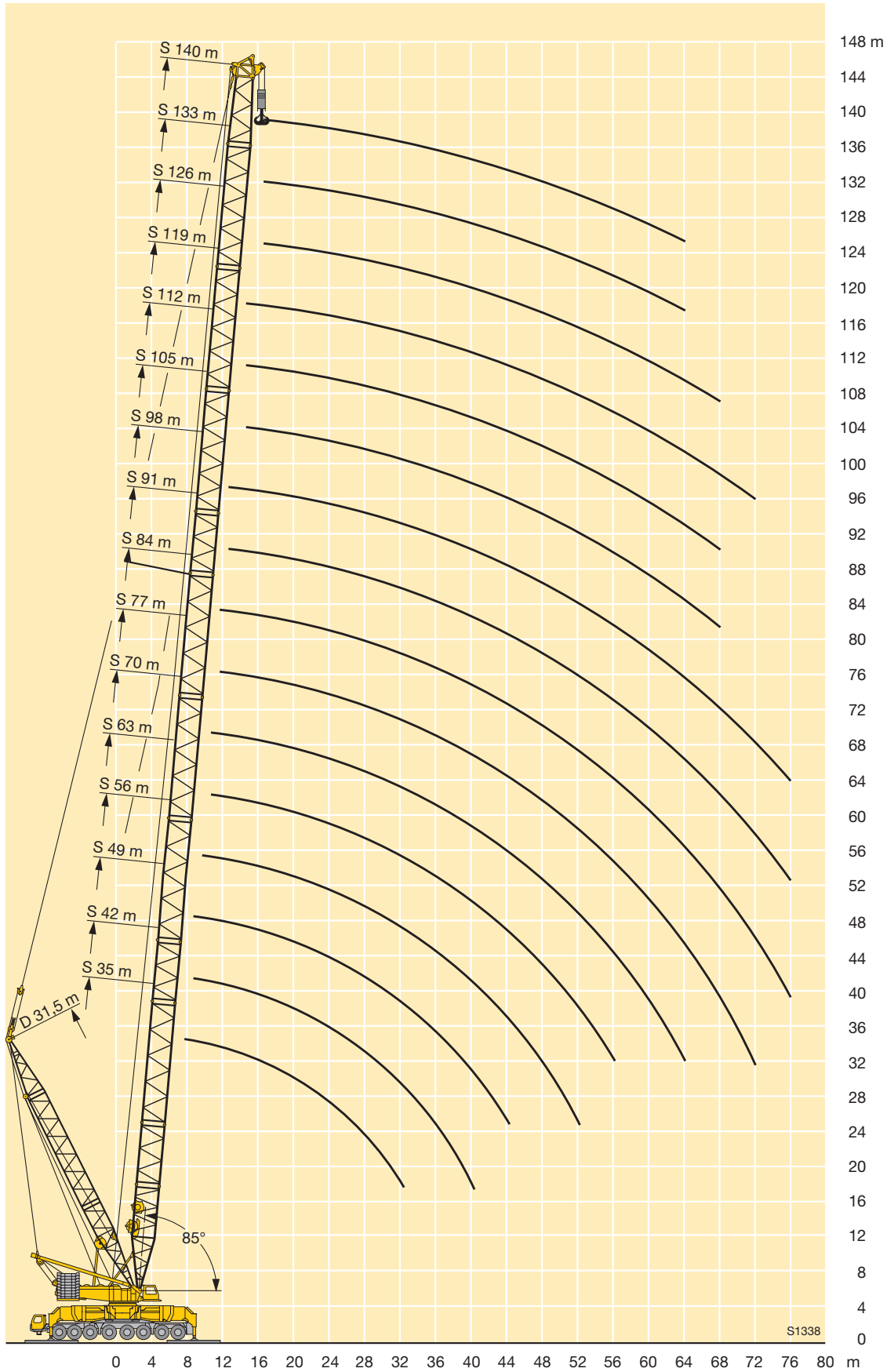

Traglasten am SDB-Auslegersystem

Lifting capacities on SDB boom/derrick combination

Forces de levage en configuration SDB

SDB



m	35 m	42 m	49 m	56 m	63 m	70 m	77 m	84 m	91 m	98 m	105 m	112 m	119 m	126 m	133 m	140 m	m
7	600																7
8	600	600	600														8
9	600	600	600	600													9
10	600	600	600	600	559	474											10
11	600	600	600	600	558	473	404	346									11
12	600	600	597	581	555	472	403	346	298	258							12
14	576	567	554	537	512	470	402	345	297	257	221	192	167				14
16	541	531	518	499	473	445	401	344	297	256	220	192	167	144	124	105	16
18	512	496	483	464	439	415	387	343	296	256	219	191	166	143	123	105	18
20	458	466	450	432	410	388	364	341	295	255	217	191	166	143	123	104	20
22	402	434	420	403	383	364	342	327	293	254	215	191	165	143	123	104	22
24	357	391	394	377	359	341	323	310	284	252	214	191	165	142	122	103	24
26	315	354	365	357	339	324	305	294	274	247	213	190	164	142	122	103	26
28	281	319	335	336	322	308	288	279	264	239	211	190	164	142	122	102	28
30	249	286	307	311	302	293	274	262	249	232	208	190	164	141	122	102	30
32	220	259	280	288	282	277	258	246	234	223	203	188	163	141	121	101	32
34		235	255	266	264	260	242	231	221	211	197	187	161	140	119	101	34
36		212	234	246	246	244	228	217	208	200	189	185	158	139	117	100	36
38		191	216	226	230	230	213	205	196	189	179	177	156	138	116	99	38
40		171	199	208	214	216	201	195	185	179	170	167	154	137	115	98	40
44			167	181	185	189	181	176	168	161	154	151	147	133	112	96	44
48				156	163	165	163	160	153	147	140	138	133	128	109	94	48
52				134	143	146	146	144	140	135	128	125	122	117	105	92	52
56					125	130	131	130	127	123	118	115	112	107	102	89	56
60						116	118	117	115	113	108	106	103	99	95	86	60
64						102	106	106	104	103	99	98	95	91	88	83	64
68							94	96	95	94	91	90	87	84	81	77	68
72							83	86	86	86	83	82	80	78	75	71	72
76								77	78	78	76	75	73	71	69	65	76
80									70	71	70	69	64	65	63	60	80
84									63	64	64	63	60	60	58	55	84
88										58	58	57	55	55	53	51	88
92											52	52	51	50	48,5	46,5	92
96											46,5	46,5	46	45	41,5	42	96
100												41,5	41	41	37,5	38	100
104													36,5	36,5	34	34	104
108													32	32,5	30,5	30,5	108
112														28,4	27	26,8	112
116															23,6	23,3	116
120															20	19,9	120
124																16,6	124

TAB 154345 / 154346 / 154347 / 154348

Traglasten am S2DB-Auslegersystem
Lifting capacities on S2DB boom/derrick combination
Forces de levage en configuration S2DB

S2DB



Vorläufig
Preliminary
Préliminaire

	35 m	42 m	49 m	56 m	63 m	70 m	
7	750						7
8	750	731	713				8
9	715	701	684	665			9
10	687	674	657	643	559	472	10
11	659	649	634	620	558	471	11
12	635	624	612	597	558	471	12
14	591	581	569	557	511	469	14
16	552	544	533	523	472	444	16
18	519	511	499	490	438	414	18
20	459	482	469	460	408	387	20
22	402	432	438	426	382	362	22
24	355	388	394	385	358	340	24
26	314	350	361	357	338	322	26
28	282	315	331	330	316	303	28
30	251	283	303	306	295	283	30
32	223	258	276	283	276	265	32
34		235	252	262	258	247	34
36		214	231	242	241	231	36
38		193	213	222	225	215	38
40		167	197	206	209	203	40
44			165	179	181	182	44
48				156	160	164	48
52				130	141	146	52
56					123	130	56
60						115	60
64						100	64

TAB 154353

Hubhöhen am S2DB-Auslegersystem
Lifting heights on S2DB boom/derrick combination
Hauteur de levage en configuration S2DB

S2DB

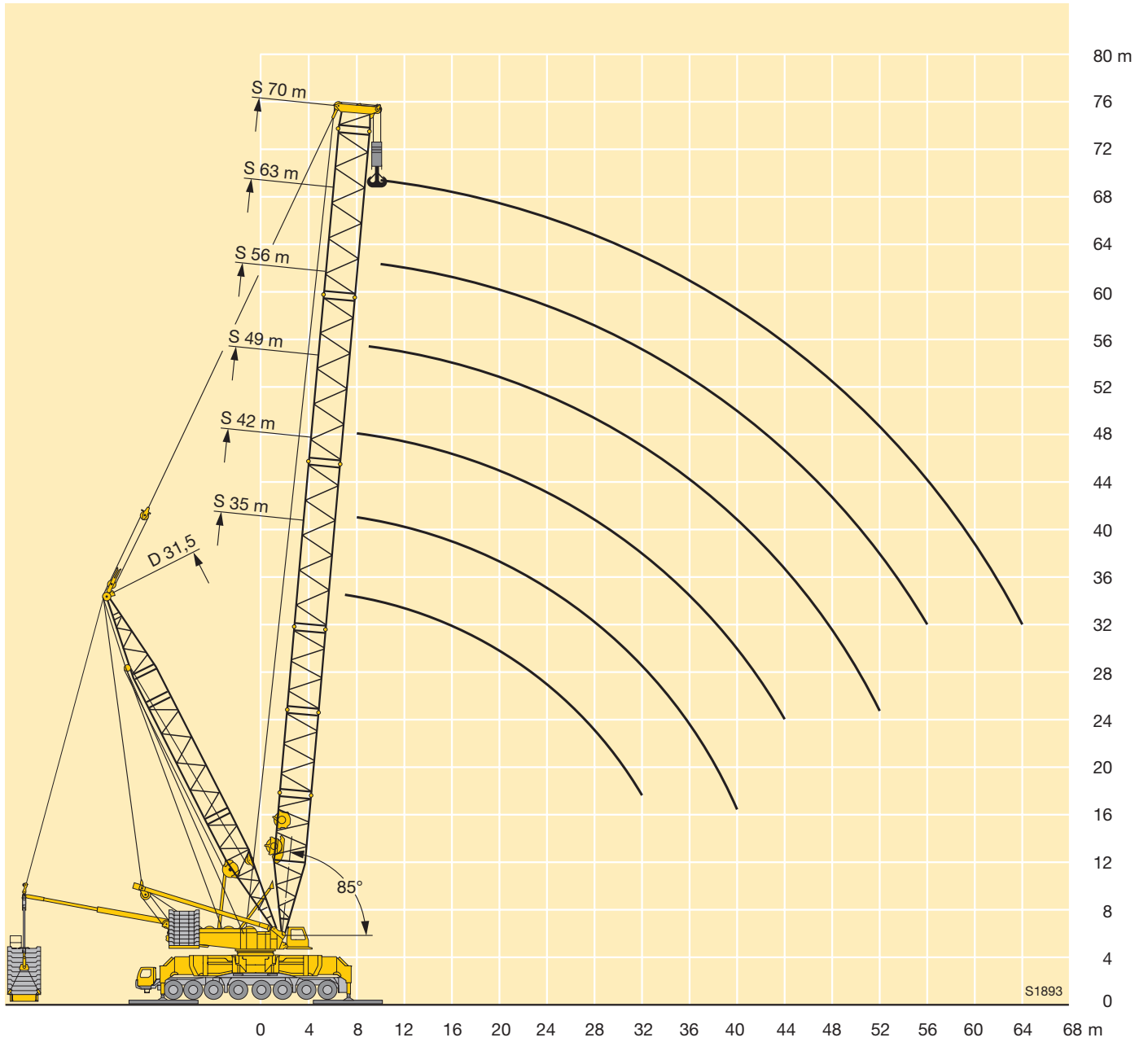

Traglasten am SD2-Auslegersystem
Lifting capacities on SD2 boom/derrick combination
Forces de levage en configuration SD2

SD2

	56 - 140 m		42 m		360°		12 x 12 m		245 t		220 t		DIN ISO		
	S		D												
m	56 m	63 m	70 m	77 m	84 m	91 m	98 m	105 m	112 m	119 m	126 m	133 m	140 m	m	
9	468													9	
10	421	418	416											10	
11	379	379	377	366	346									11	
12	324	334	345	333	316	300	272							12	
14	267	263	292	280	265	255	244	234	202	173				14	
16	222	221	224	240	215	220	211	204	196	172	150	129	113	16	
18	187	185	184	188	179	189	185	179	173	166	149	129	112	18	
20	163	159	161	160	155	156	158	158	153	147	143	129	111	20	
22	142	139	139	141	136	134	132	133	135	132	127	122	111	22	
24	125	122	120	123	120	118	116	117	119	117	114	109	105	24	
26	113	108	108	107	104	104	103	101	104	103	103	98	94	26	
28	103	98	99	94	92	91	91	88	89	90	90	86	85	28	
30	94	90	91	84	82	80	79	78	78	77	79	74	73	30	
32	85	82	83	76	74	72	70	70	69	67	68	65	63	32	
34	77	75	76	69	66	64	63	62	62	60	59	58	55	34	
36	70	68	69	61	59	58	56	55	55	54	53	51	49	36	
38	63	62	63	55	53	51	50	48,5	48,5	47,5	47	45	43	38	
40	57	56	57	49,5	48,5	45,5	44,5	43,5	42,5	41,5	41	39	37,5	40	
44	50	44,5	45,5	41	40	37,5	35,5	34,5	33	31,5	31	28,3	26,7	44	
48	44	38,5	35	33,5	32,5	30,5	28,8	25,9	25,1	23,1	23	20,4	18	48	
52	39	34	29,9	26,7	25,6	24,5	23,1	20	18,6	17,3	16,8	14,4	12,6	52	
56		29,6	25,9	22,4	19,2	18,6	17,9	15,1	14,4	13,9	11,1	9	8,5	56	
60			22,2	19,1	15,2	13,1	13	10,6	11,2	11,3	7,7	5,3		60	
64			18,7	16,1	12,6	9,2	8,4	6,7	8,2	8,8	5,6			64	
68				13,3	10,3	6,5	5,3		5,4	6,6				68	
72				10,6	8,2									72	
76					6,2									76	

TAB 154410 / 154411

Hubhöhen am SD2-Auslegersystem
Lifting heights on SD2 boom/derrick combination
Hauteur de levage en configuration SD2

SD2

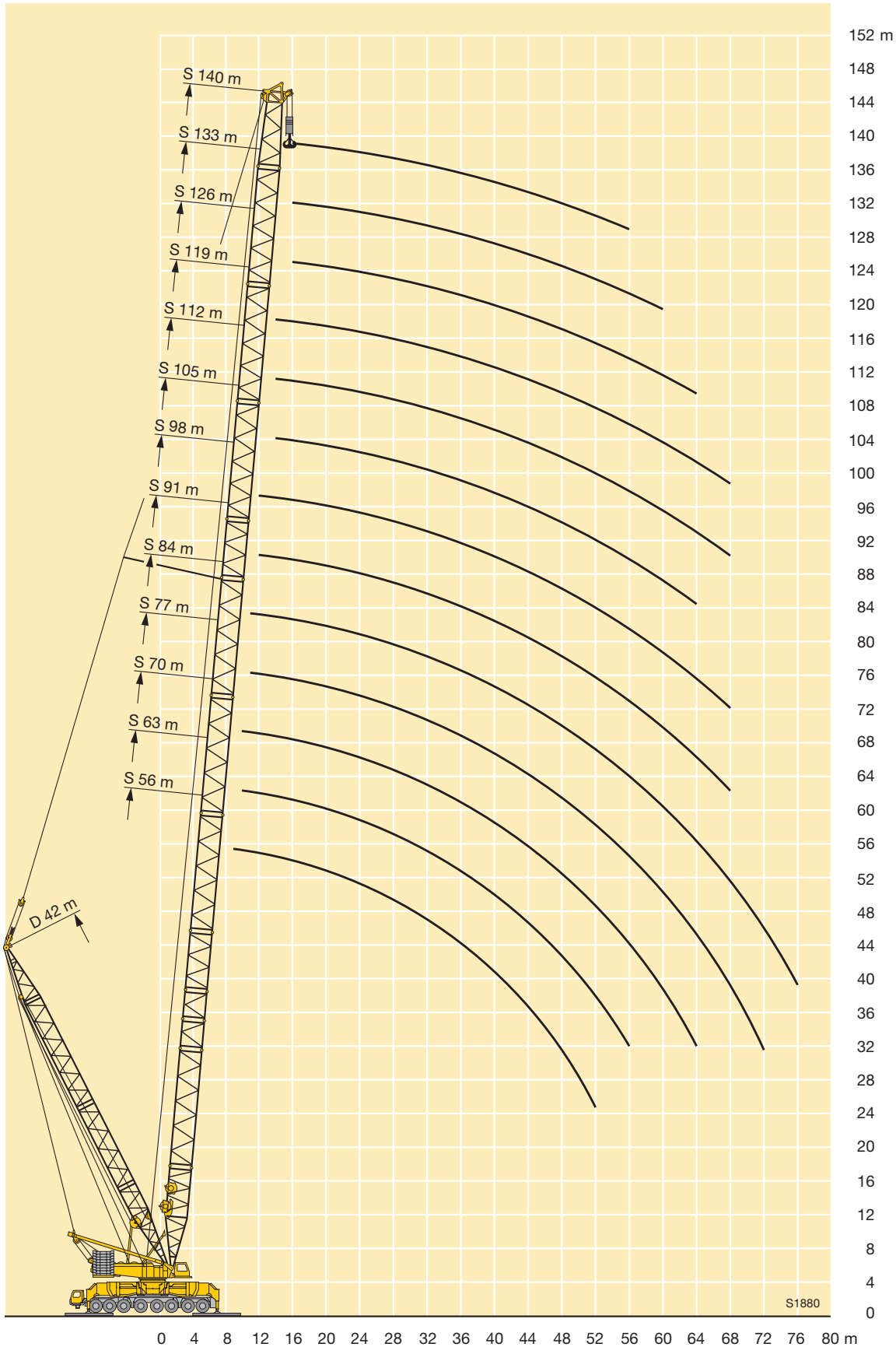

Traglasten am SD2B-Auslegersystem
Lifting capacities on SD2B boom/derrick combination
Forces de levage en configuration SD2B

SD2B



	56 m	63 m	70 m	77 m	84 m	91 m	98 m	105 m	112 m	119 m	126 m	133 m	140 m	
9	600													9
10	600	600	509											10
11	600	600	509	431	367									11
12	600	593	503	423	367	316	272							12
14	546	553	473	401	363	316	272	234	202	173				14
16	506	488	445	381	344	311	272	233	202	172	152	129	113	16
18	470	451	420	362	327	296	268	233	201	172	151	129	112	18
20	437	418	398	344	311	282	256	233	201	171	150	129	111	20
22	397	390	375	328	298	269	244	230	200	171	150	128	111	22
24	352	365	350	314	286	259	234	220	199	170	149	128	110	24
26	321	334	331	301	275	250	227	210	193	169	149	128	110	26
28	295	307	314	287	264	241	219	200	184	167	148	128	109	28
30	271	283	293	272	255	233	212	193	177	161	148	127	108	30
32	248	261	272	259	246	225	206	188	171	154	147	127	108	32
34	227	241	252	241	236	218	200	182	166	150	144	126	107	34
36	207	221	233	222	224	212	194	178	162	146	141	125	106	36
38	188	203	215	204	211	205	189	173	158	143	138	123	106	38
40	172	185	198	189	199	194	184	169	154	139	135	121	104	40
44	149	154	165	166	176	172	172	160	147	133	130	118	101	44
48	130	134	137	145	156	153	156	150	140	127	125	113	99	48
52	111	117	120	126	137	135	139	137	130	122	118	107	96	52
56		101	107	111	119	120	124	124	119	114	112	100	91	56
60			95	98	105	105	110	112	109	105	103	94	86	60
64			84	86	93	93	97	101	100	97	94	88	82	64
68				76	83	83	86	90	91	90	86	81	78	68
72				68	72	74	78	81	83	82	78	75	74	72
76					63	67	71	74	76	75	71	69	69	76
80						60	64	67	68	69	65	63	64	80
84						53	58	61	61	62	59	57	60	84
88							52	55	54	56	54	53	55	88
92								49,5	49	50	48,5	49,5	50	92
96								44	44	44,5	43,5	45,5	46	96
100									39	39,5	39	41,5	42	100
104										34	35	37,5	38,5	104
108										28,7	31	33,5	34,5	108
112											26,7	29,4	31	112
116												25,5	27,8	116
120												21,6	24,3	120
124													20,8	124

TAB 154412 / 154413

Hubhöhen am SD2B-Auslegersystem
Lifting heights on SD2B boom/derrick combination
Hauteur de levage en configuration SD2B

SD2B

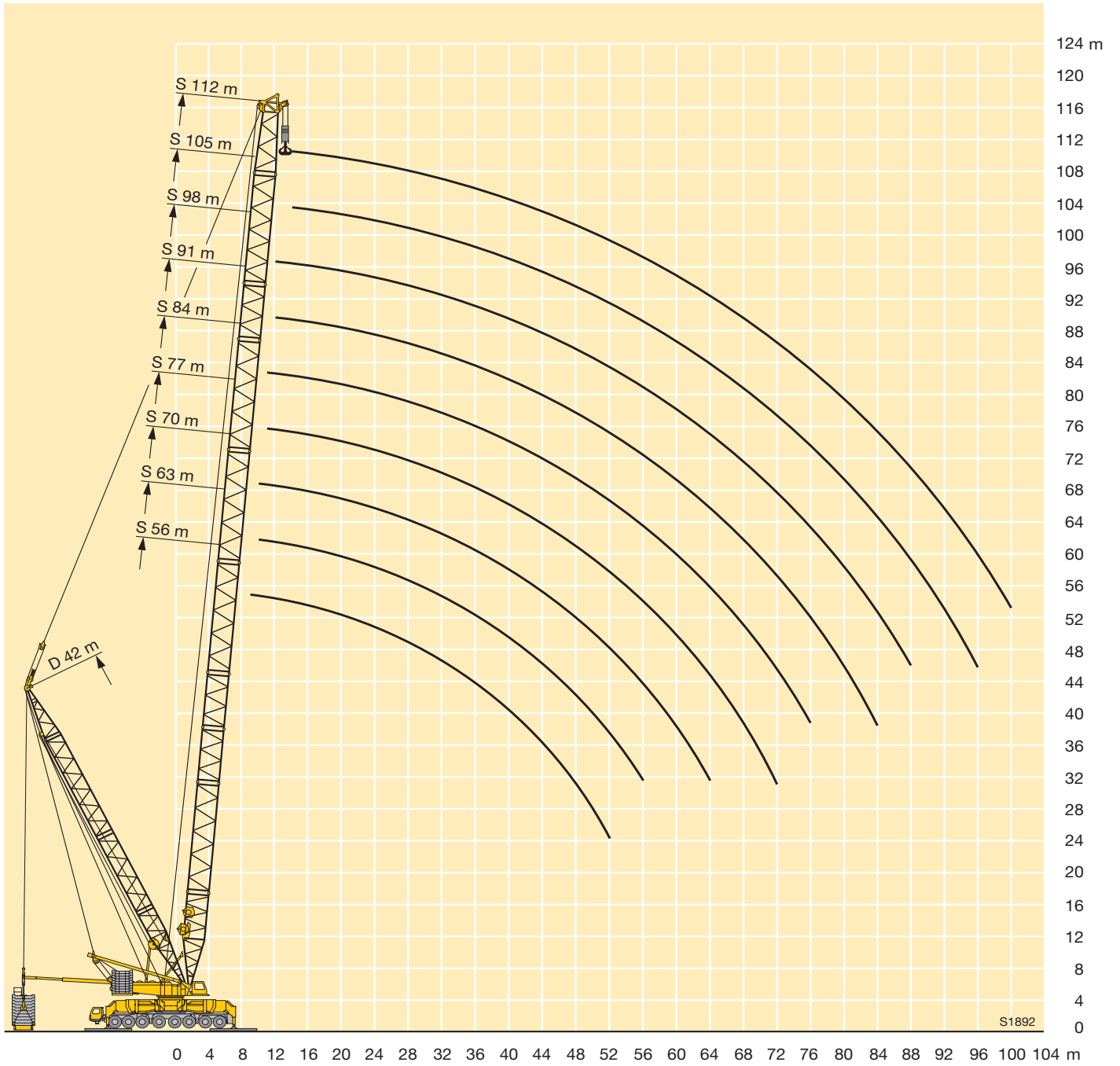

Traglasten am SLD-Auslegersystem

Lifting capacities on SLD boom/derrick combination

Forces de levage en configuration SLD

SLD

m	35 - 140 m		31,5 m		360°		12 x 12 m		245 t		220 t		DIN ISO		m		
	SL	D	SL	D	SL	D	SL	D	SL	D	SL	D	SL	D			
	35 m	42 m	49 m	56 m	63 m	70 m	77 m	84 m	91 m	98 m	105 m	112 m	119 m	126 m	133 m		
7	400															7	
8	400	400	400													8	
9	400	400	400	400												9	
10	400	400	397	382	393	371										10	
11	371	360	357	348	336	330	328	301								11	
12	338	318	321	316	307	296	304	294	253	225						12	
14	279	262	256	260	256	251	246	247	238	222	182	165	134			14	
16	227	221	220	214	211	211	211	206	204	201	180	163	132	120	100	16	
18	195	192	189	187	183	178	179	171	174	175	166	162	131	119	100	18	
20	174	170	165	163	159	156	154	152	151	153	148	142	130	118	100	20	
22	155	151	147	143	141	137	137	134	134	132	131	126	123	117	100	22	
24	137	133	131	128	125	123	121	118	119	114	116	112	110	106	100	24	
26	123	121	120	116	114	110	109	105	106	103	102	99	98	95	93	26	
28	115	110	109	107	105	100	98	95	95	92	91	87	87	85	83	28	
30	107	100	100	99	97	93	89	86	86	82	83	79	77	75	74	30	
32	99	94	91	91	90	86	83	77	78	76	75	71	70	67	65	32	
34		89	83	83	83	79	77	72	72	70	67	64	63	61	58	34	
36		83	78	76	76	73	71	67	67	65	61	57	57	55	53	36	
38		78	73	69	70	68	66	62	61	60	56	52	52	49,5	48	38	
40		73	69	64	64	62	61	58	57	55	51	47,5	46	44,5	43	40	
44			62	58	53	52	52	49,5	47,5	45,5	43	39	38	35,5	34	44	
48				52	47,5	43	44	41,5	38,5	37	37	33,5	30	27,7	25,2	48	
52				46	42,5	38,5	36	34,5	32,5	28,9	30,5	28,1	24,6	20,6	19,5	52	
56					38	34,5	32	27,3	27,3	24	25,1	23,4	20,4	17,4	14,7	56	
60						30,5	28,2	23,4	22,3	19,4	19,8	19	16,5	14,7	10,1	60	
64						26,8	24,9	20,6	19	15,1	14,8	14,8	12,8	12,1	6,4	64	
68								21,8	17,9	16,6	12,3	11,5	10,9	9,4	9,8	5,4	68
72								18,8	15,4	14,4	10,6	9,9	7,1	6,2	7,5	4,4	72
76									13	12,3	9	8,4	4,3	4	5,4	3,5	76
80										10,2	7,5	7	3,6	3,4			80
84											6,1	5,7					84
88											4,7	4,4					88
92												3,2					92

TAB 154173 / 154174

Hubhöhen am SLD-Auslegersystem
Lifting heights on SLD boom/derrick combination
Hauteur de levage en configuration SLD

SLD

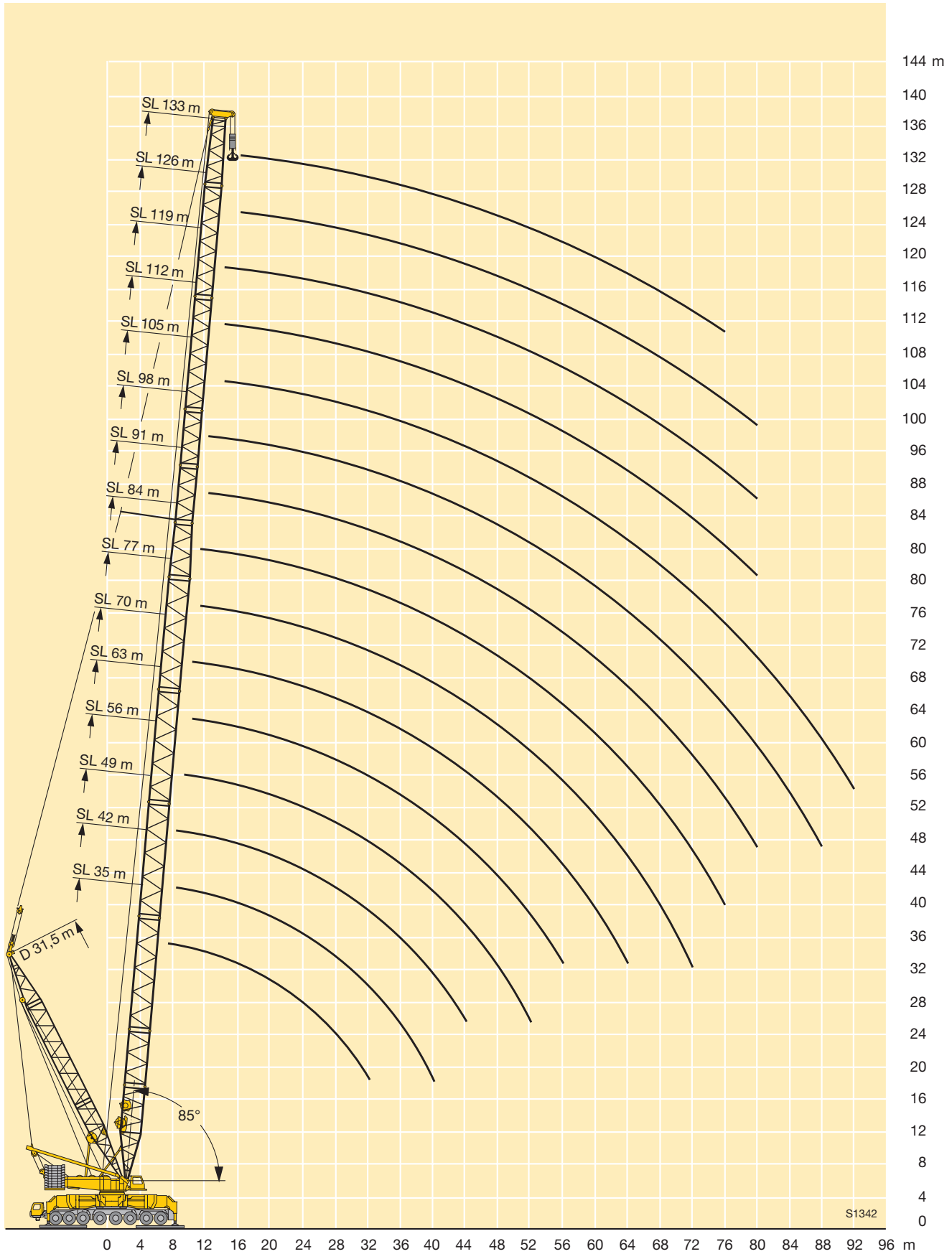

Traglasten am SLDB-Auslegersystem

Lifting capacities on SLDB boom/derrick combination

Forces de levage en configuration SLDB

SLDB



	35 m	42 m	49 m	56 m	63 m	70 m	77 m	84 m	91 m	98 m	105 m	112 m	119 m	126 m	133 m	
7	400															7
8	400	400	400													8
9	400	400	400	400												9
10	400	400	400	400	393	371										10
11	400	400	400	400	392	370	328	301								11
12	400	400	400	400	391	370	328	301	246	223						12
14	400	400	400	400	389	368	327	301	244	221	181	162	132			14
16	400	400	400	398	387	367	326	300	243	218	179	161	131	119	100	16
18	400	400	400	396	385	366	326	299	242	217	178	160	130	118	100	18
20	400	400	400	394	384	365	325	290	239	215	176	159	130	117	100	20
22	395	400	395	381	373	361	322	281	231	213	175	158	129	116	100	22
24	357	375	371	357	348	339	313	272	224	210	174	157	128	116	100	24
26	321	346	345	337	328	322	300	264	218	205	172	157	128	115	99	26
28	286	321	320	319	312	306	290	257	212	201	170	156	127	114	99	28
30	254	293	300	299	297	291	280	249	206	197	165	154	127	114	98	30
32	225	267	281	280	279	278	268	237	201	191	161	150	126	113	97	32
34		242	263	264	263	262	255	230	191	186	157	146	126	112	95	34
36		219	242	250	249	248	242	222	186	181	153	143	123	112	93	36
38		198	224	230	236	235	225	213	181	176	149	140	120	111	90	38
40		177	207	214	220	225	212	204	176	171	145	137	118	109	88	40
44			174	190	189	197	190	187	167	162	137	129	113	105	84	44
48				165	172	168	169	170	159	155	130	124	108	101	81	48
52				141	152	153	151	152	149	143	124	119	104	98	78	52
56					134	139	138	135	134	132	118	113	99	93	75	56
60						124	128	123	120	120	113	109	95	90	71	60
64						110	116	114	109	107	108	104	91	86	68	64
68							104	105	101	97	98	97	87	83	65	68
72							93	95	94	90	89	88	83	80	63	72
76								86	86	84	83	79	79	77	60	76
80									78	78	77	74	73	71	58	80
84										71	72	69	68	66	55	84
88										65	66	64	63	61	53	88
92											60	59	59	57	51	92
96											55	54	54	53	49	96
100												49	49,5	48,5	45,5	100
104													45,5	44,5	41,5	104
108													41	40,5	38,5	108
112														36,5	35	112
116															30	116
120															26	120

TAB 154349 / 154350 / 154351 / 154352

Hubhöhen am SLDB-Auslegersystem
Lifting heights on SLDB boom/derrick combination
Hauteur de levage en configuration SLDB

SLDB

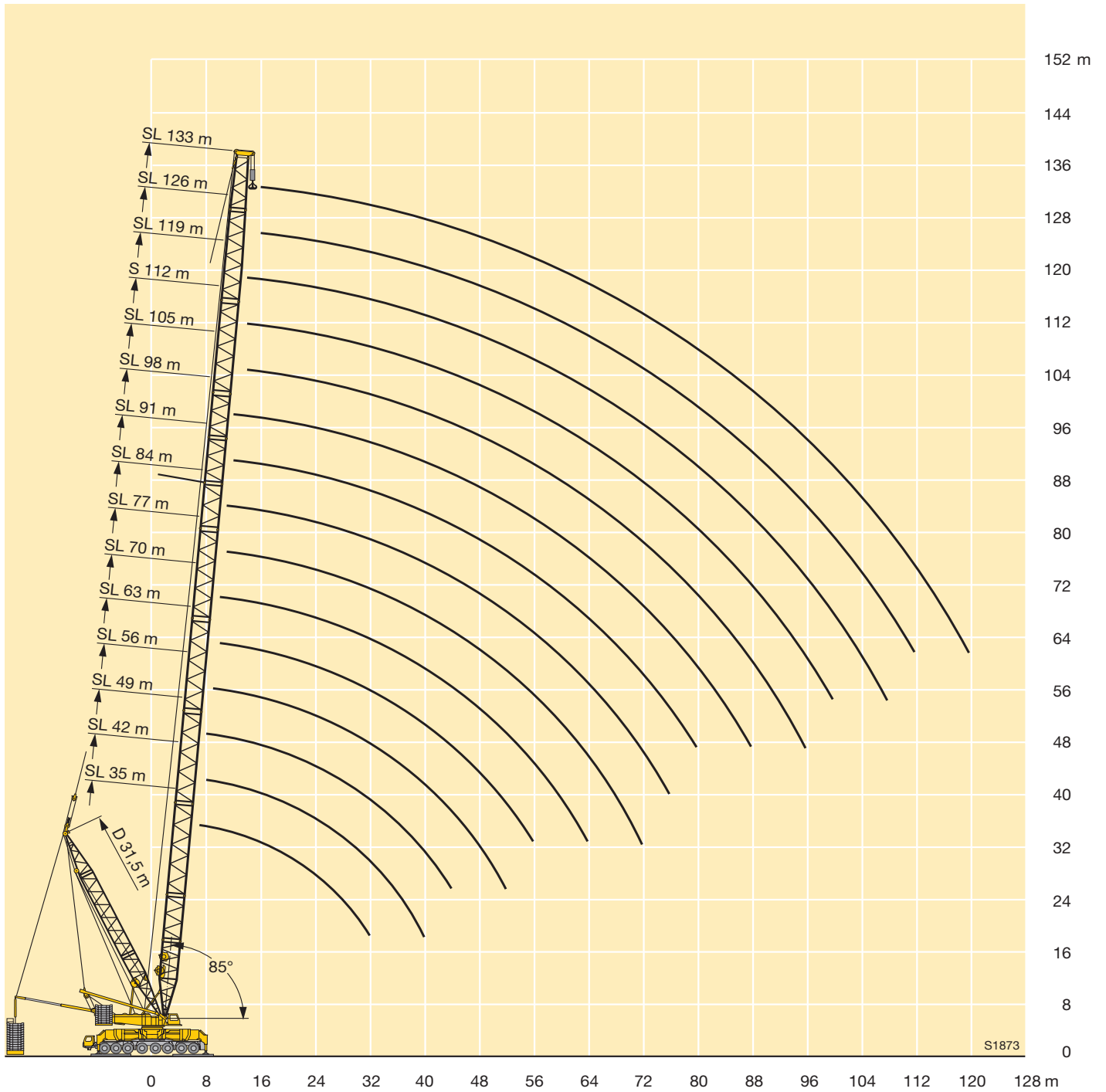

Traglasten am SL9D2F-Auslegersystem
Lifting capacities on SL9D2F boom/derrick combination
Forces de levage en configuration SL9D2F

SL9D2F

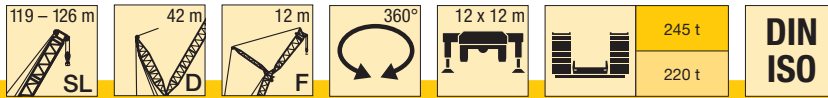

	119 m	122 m	126 m	
22	124	123	122	22
24	108	107	106	24
26	95	93	92	26
28	83	82	81	28
30	74	73	71	30
32	66	65	64	32
34	59	57	56	34
36	52	50	49,5	36
38	46	44,5	43,5	38
40	41,5	39,5	38	40
44	32,5	31	29,6	44
48	24,8	23	21,7	48
52	17,5	15,8	14,5	52
56	12,5	10,4	8,6	56
60	8,8	7,2		60

TAB 154391 / 154392

Hubhöhen am SL9D2F-Auslegersystem
Lifting heights on SL9D2F boom/derrick combination
Hauteur de levage en configuration SL9D2F

SL9D2F

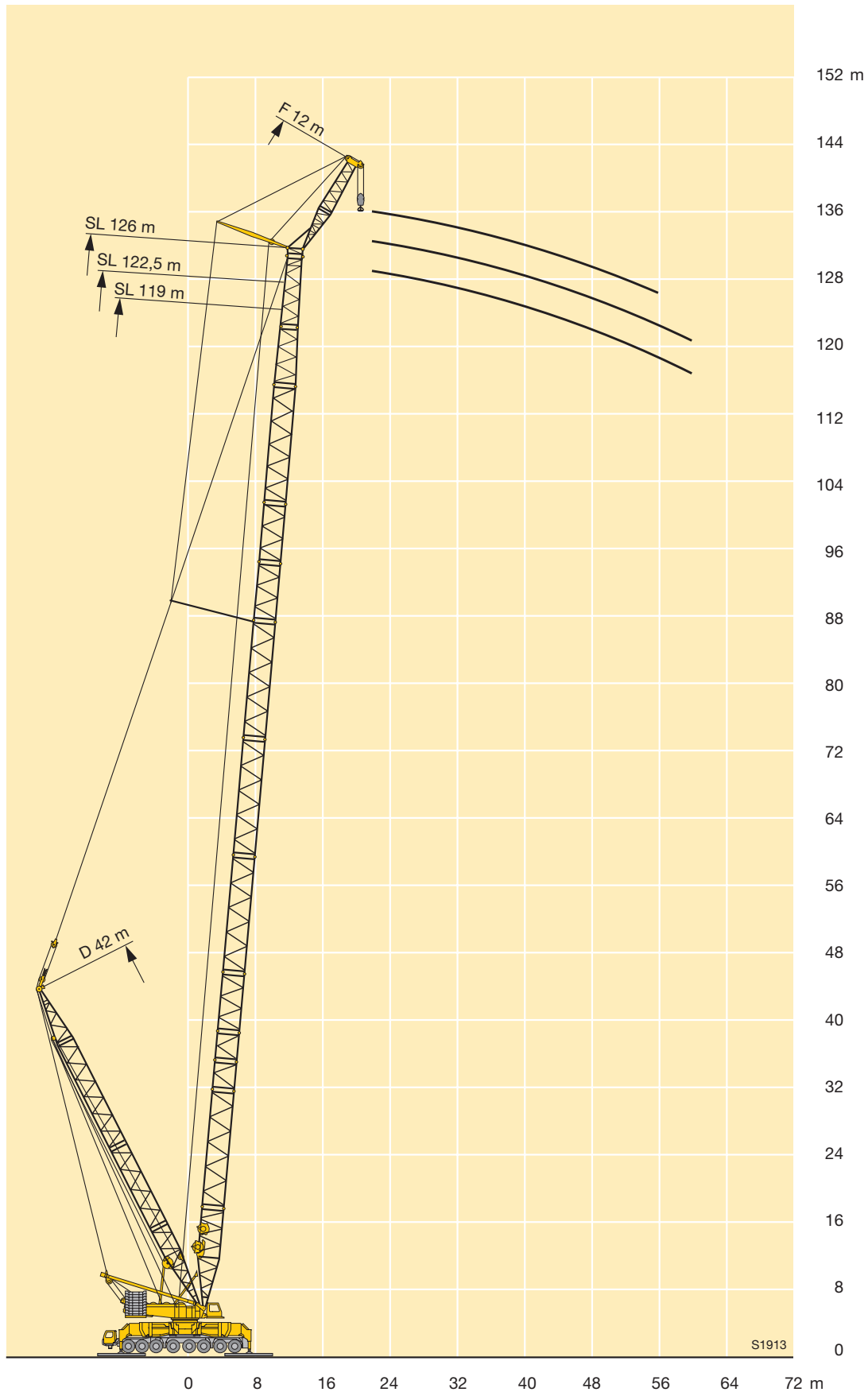

Traglasten am SL9D2FB-Auslegersystem
Lifting capacities on SL9D2FB boom/derrick combination
Forces de levage en configuration SL9D2FB

SL9D2FB

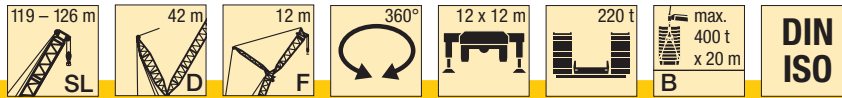

	119 m	122 m	126 m	
22	147	142	137	22
24	146	141	136	24
26	144	140	135	26
28	143	139	134	28
30	141	138	133	30
32	138	136	131	32
34	136	134	130	34
36	134	133	129	36
38	132	131	128	38
40	129	127	124	40
44	117	119	116	44
48	101	111	109	48
52	87	102	102	52
56	75	88	96	56
60	67	78	90	60
64	59	69	83	64
68	52	61	73	68
72	46,5	54	64	72
76	42	48,5	58	76
80	37,5	44	52	80
84	33,5	39,5	47,5	84
88	29,9	35,5	43	88
92	26,8	31,5	38,5	92
96	24,7	28,8	34,5	96
100	22,9	26,7	32	100
104	21,2	24,8	29,9	104
108	19,6	23	27,8	108
112	18,8	21,2	25,8	112
116	18,8	20,9	24,2	116
120		20,9	24,1	120

TAB 154389 / 154390

Hubhöhen am SL9D2FB-Auslegersystem
Lifting heights on SL9D2FB boom/derrick combination
Hauteur de levage en configuration SL9D2FB

SL9D2FB

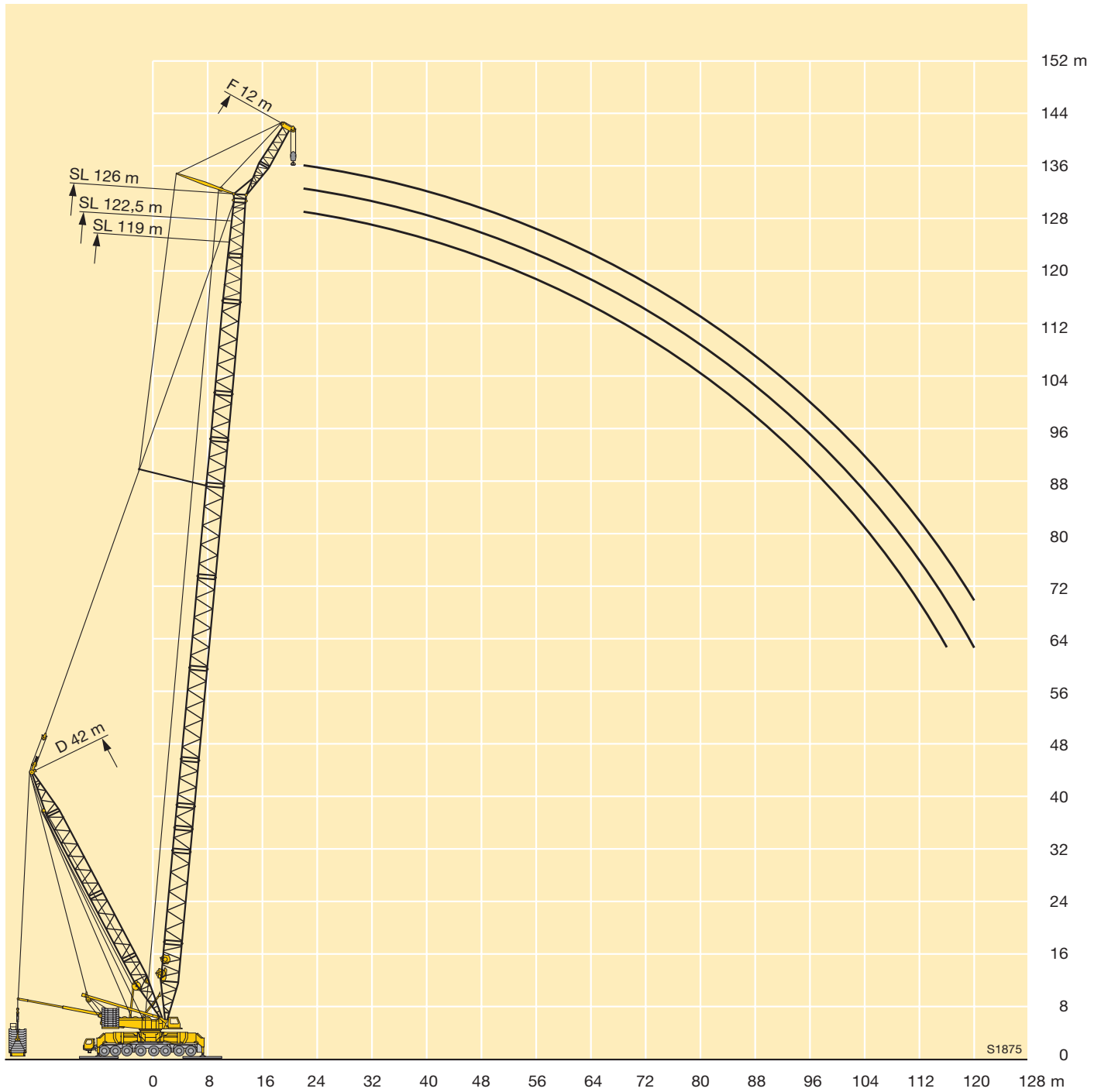

Traglasten am SW-Auslegersystem

Lifting capacities on SW boom/jib combination

Forces de levage en configuration SW

SW

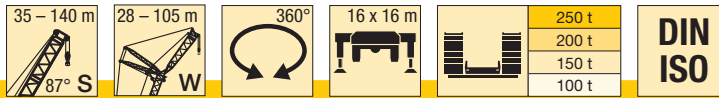

m	35 m										42 m										m				
	28 m	35 m	42 m	49 m	56 m	63 m	70 m	77 m	84 m	91 m	98 m	105 m	28 m	35 m	42 m	49 m	56 m	63 m	70 m	77 m		84 m	91 m	98 m	105 m
14	326											325												14	
16	288	287	281									286	284											16	
18	254	252	252	229								252	251	242	208									18	
20	226	225	224	220	188							224	222	221	205	174								20	
22	203	202	201	200	186	158						200	199	197	195	172	144							22	
24	185	183	183	182	179	156	131	112				180	180	178	176	168	143	122						24	
26	169	168	167	166	165	154	130	111	93			165	163	163	160	158	142	121	104	89				26	
28	155	154	154	152	152	149	128	110	92	79		150	149	150	148	145	139	120	103	88	74			28	
30	143	143	141	141	140	139	127	110	91	78	66	138	138	137	136	134	132	119	102	87	73	63		30	
32		131	131	130	130	129	124	109	90	78	65	56	127	126	126	125	123	117	102	86	73	62	53	32	
34		122	122	120	121	120	117	108	90	77	65	55	118	118	116	116	115	112	101	85	72	61	53	34	
36		114	113	112	112	112	110	106	89	76	64	55	110	110	108	108	107	105	100	84	72	61	52	36	
38		106	106	105	104	104	103	100	88	75	64	54	103	102	101	100	100	98	96	83	72	60	52	38	
40			99	98	97	97	96	94	88	75	63	54		96	95	93	93	92	90	83	72	60	51	40	
44				88	87	86	85	84	83	84	73	62	53		85	83	83	81	80	79	72	59	51	44	
48					77	76	75	73	73	74	69	61	52			75	73	72	71	70	70	67	58	50	48
52						68	67	66	65	69	63	60	51				66	64	63	62	62	60	56	48,5	52
56						62	60	59	58	61	57	56	50				59	58	57	56	55	53	53	47,5	56
60							55	53	53	51	50	50	47,5					52	51	50	49	47,5	47	45,5	60
64							49,5	48	47	47	45,5	44,5	43,5					47	46	45	44,5	43	42,5	41	64
68								43,5	43	42	41	40,5	39						42	40,5	40	39	38	36,5	68
72								39,5	39	38	37	36,5	35						38	37	36	35	34,5	33	72
76									35,5	34,5	33,5	33	31,5							33,5	32,5	31,5	31	29,5	76
80										31,5	30	29,4	28,4								29,6	28,2	27,5	26,4	80
84										28,5	27,4	26,5	25,3							26,7	25,6	24,7	23,5	84	
88											24,8	24	22,6								23	22,2	20,8	88	
92												22,2	21,6	20,2								20,6	19,9	18,5	92
96													19,3	18,1								17,7	16,4	96	
100														17,1	16								15,6	14,4	100
104															14,1									12,5	104

TAB 154222 / 154224 / 154441 / 154443

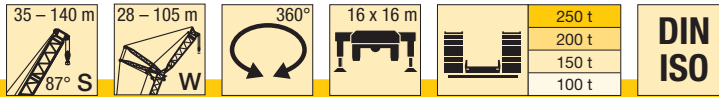

m	49 m										56 m										m						
	28 m	35 m	42 m	49 m	56 m	63 m	70 m	77 m	84 m	91 m	98 m	105 m	28 m	35 m	42 m	49 m	56 m	63 m	70 m	77 m		84 m	91 m	98 m	105 m		
14	316																							14			
16	282	263											266	237										16			
18	245	241	222										236	226	198									18			
20	216	214	211	185	158								209	206	193	166								20			
22	193	192	189	180	155	133							188	185	183	163	139	122						22			
24	174	174	171	170	152	131	111						169	169	166	159	137	120	104					24			
26	159	158	157	155	148	128	109	96					154	153	152	150	135	119	103	89				26			
28	146	144	144	142	140	126	108	95	80	72			141	140	140	137	132	117	101	88	74			28			
30	134	133	132	132	129	124	106	94	80	71	59		130	129	128	127	125	116	100	87	74	64	55	30			
32	124	123	122	122	121	117	105	94	79	70	58	49,5	120	120	118	118	116	114	99	86	73	64	54	45,5	32		
34		114	113	113	112	109	104	93	79	69	58	49		111	110	109	108	106	98	85	73	63	53	45,5	34		
36		106	106	104	104	102	100	92	78	68	57	48,5		103	103	101	101	100	97	84	72	63	53	45	36		
38		99	98	98	97	96	94	90	78	67	57	48		97	96	94	93	91	83	72	63	53	44,5	38			
40			92	92	90	89	88	87	77	66	56	47,5			90	89	87	87	85	83	71	62	52	44,5	40		
44				82	81	80	78	77	77	73	64	55	47			79	78	77	76	75	73	69	61	51	43,5	44	
48					72	71	69	68	68	67	62	54	46				70	69	67	66	65	63	59	50	43	48	
52						64	63	62	61	60	59	58	53	45,5				62	61	60	58	58	56	49,5	52		
56							57	55	54	54	52	51	50	45					55	54	52	51	50	49,5	56		
60								50	48,5	48,5	47	45,5	45	43						48,5	46,5	46,5	44,5	44	43	60	
64								45	44	43,5	42	40,5	40	38,5						43,5	42	41,5	40	39,5	38	64	
68									40	39	38	36,5	36	34,5							38	37,5	36	35,5	34	32,5	68
72									36	35,5	34	33	32,5	30,5							34,5	33,5	32	32	30,5	28,8	72
76										32	30,5	29,4	28,9	27,5								30,5	29	28,4	27,2	25,7	76
80										28,8	27,8	26,4	25,7	24,5								27,3	26,2	25,4	24,1	22,8	80
84											25	23,8	22,9	21,7									23,5	22,8	21,3	20	84
88												21,3	20,5	19,1										20,4	18,9	17,5	88
92													19	18,3	16,8									18,1	16,8	15,3	92
96														16,2	14,8										14,7	13,4	96
100															14,1	12,9									12,7	11,5	100
104																11									9,8	104	
108																	9,3								8,1	108	

TAB 154222 / 154224 / 154441 / 154443

Traglasten am SW-Auslegersystem

Lifting capacities on SW boom/jib combination

Forces de levage en configuration SW

SW

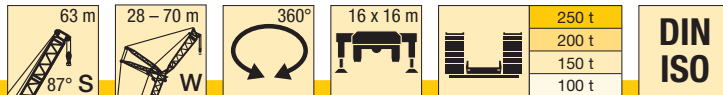

m	63 m							m
	28 m	35 m	42 m	49 m	56 m	63 m	70 m	
16	240							16
18	226	204	177					18
20	203	197	172	148				20
22	182	179	167	146	128			22
24	165	163	160	144	126	109	95	24
26	150	149	147	142	124	107	93	26
28	138	136	135	133	122	106	92	28
30	127	125	125	123	120	104	91	30
32	118	116	115	114	113	103	90	32
34		108	107	106	105	101	89	34
36		101	100	98	98	96	88	36
38		94	93	92	91	90	87	38
40			87	86	85	84	83	40
44			77	76	75	73	73	44
48				68	67	65	64	48
52				60	60	58	57	52
56					53	51	51	56
60						46	45,5	60
64						41,5	40,5	64
68							37	68
72							33	72

TAB 154222 / 154224 / 154441 / 154443

Hubhöhen am SW-Auslegersystem
Lifting heights on SW boom/jib combination
Hauteur de levage en configuration SW

SW

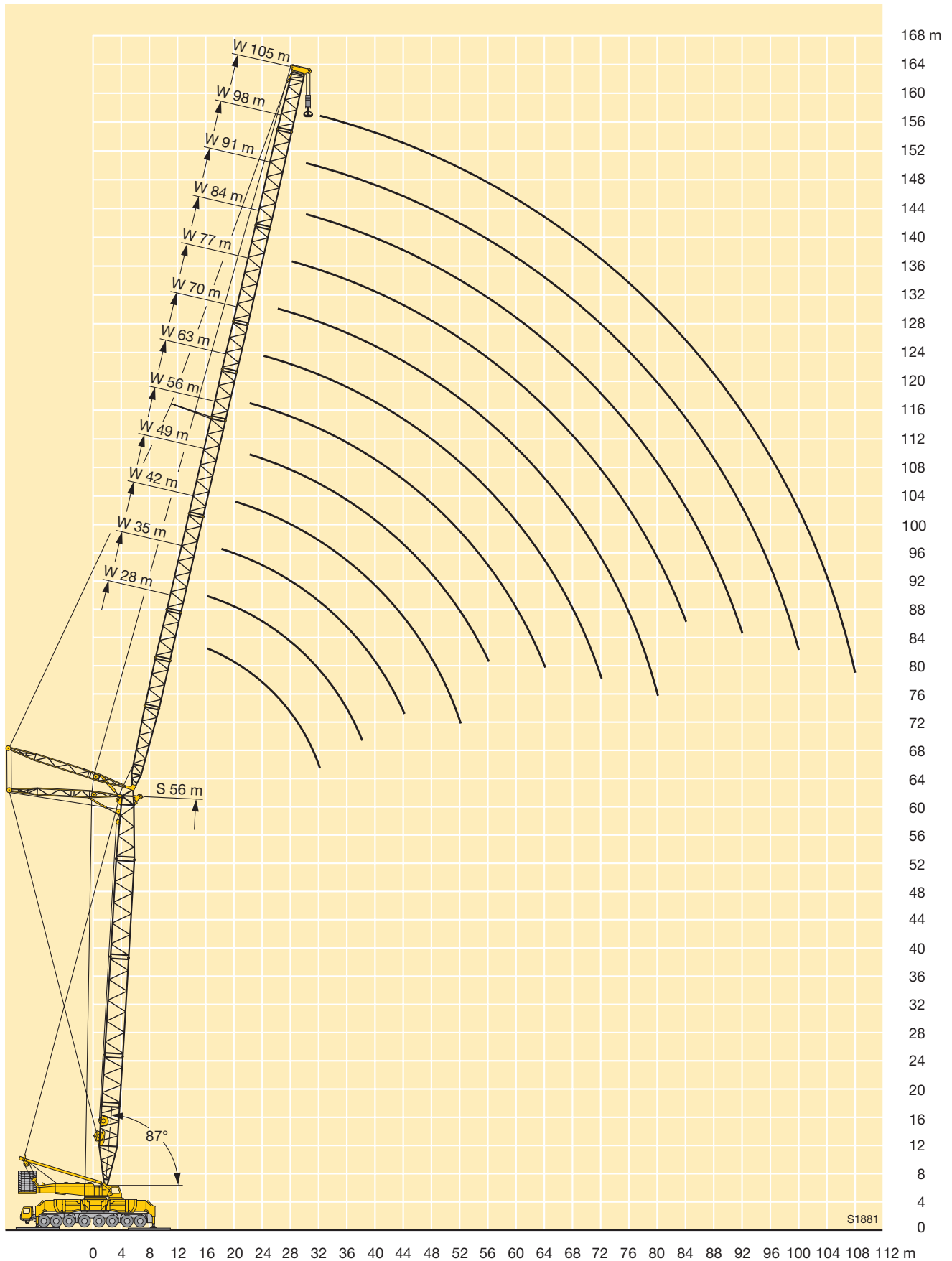

Traglasten am SW-Auslegersystem

Lifting capacities on SW boom/jib combination

Forces de levage en configuration SW

SW



35 – 63 m
87° S



28 – 105 m
W



360°



12 x 12 m



DIN
ISO

245 t

220 t

195 t

170 t

m	35 m										42 m										m				
	28 m	35 m	42 m	49 m	56 m	63 m	70 m	77 m	84 m	91 m	98 m	105 m	28 m	35 m	42 m	49 m	56 m	63 m	70 m	77 m		84 m	91 m	98 m	105 m
14	294											286												14	
16	255	250	240									248	238											16	
18	223	220	212	204								219	211	203	196									18	
20	199	196	190	183	177							196	189	182	176	170								20	
22	179	177	171	165	160	155						177	170	165	159	154	144							22	
24	162	161	156	150	146	141	131	112				161	155	151	145	140	135	122						24	
26	148	147	143	138	134	129	125	111	93			147	142	138	133	129	124	121	104	89				26	
28	136	135	132	127	124	119	115	110	92	79		135	131	127	123	119	115	112	103	88	74			28	
30	126	125	122	118	115	111	106	104	91	78	66	125	122	118	114	110	106	103	100	87	73	63		30	
32		116	114	109	107	103	99	96	90	78	65	56	114	110	106	103	99	96	93	86	73	62	53	32	
34		108	106	102	99	96	92	90	88	77	65	55	106	103	99	96	92	90	86	84	72	61	53	34	
36		101	99	96	93	90	86	84	82	76	64	55	100	97	93	90	86	84	81	79	72	61	52	36	
38		94	94	90	87	84	81	79	77	74	64	54	94	91	87	84	81	79	76	74	71	60	52	38	
40			88	85	82	79	76	74	72	69	63	54		86	82	79	76	74	71	69	67	60	51	40	
44			77	76	73	70	67	66	64	61	60	53		77	74	71	68	66	63	61	59	58	51	44	
48				67	66	63	60	58	57	55	53	51			67	64	61	59	56	55	52	51	49	48	
52					59	57	54	52	51	48,5	47,5	45,5				58	55	53	50	49	47	45,5	43,5	52	
56					53	52	49	47,5	46	43,5	42,5	40,5				53	50	48	45,5	44	42	41	39	56	
60						47	44,5	43	41,5	39,5	38	36,5					45,5	43,5	41	40	37,5	36,5	34,5	60	
64						42,5	40,5	39	37,5	35,5	34,5	32,5					42	39,5	37,5	36	34	33	31	64	
68							37	35,5	34	32	31	29,1						36,5	34	32,5	30,5	29,6	27,8	68	
72							34	32,5	31	29	27,9	26,1						33,5	31	29,6	27,7	26,7	24,8	72	
76								29,9	28,3	26,3	25,2	23,4								28,5	27	25	24	22,2	76
80									25,9	23,9	22,7	21									24,6	22,7	21,6	19,8	80
84									23,8	21,7	20,5	18,8									22,6	20,5	19,4	17,7	84
88										19,8	18,5	16,7									18,7	17,5	15,7		88
92										18,1	16,7	14,9										17	15,7	13,9	92
96											15,1	13,3											14,1	12,3	96
100											13,7	11,8											12,7	10,8	100
104												10,4												9,5	104

TAB 154454 / 154455 / 154456 / 154457

m	49 m										56 m										m					
	28 m	35 m	42 m	49 m	56 m	63 m	70 m	77 m	84 m	91 m	98 m	105 m	28 m	35 m	42 m	49 m	56 m	63 m	70 m	77 m		84 m	91 m	98 m	105 m	
14	271																							14		
16	237	227											226	217										16		
18	210	202	194										200	193	186									18		
20	188	181	174	169	158								180	174	168	162								20		
22	170	164	158	153	148	133							163	158	152	147	139	122						22		
24	155	150	144	140	136	130	111						149	144	139	134	130	120	104					24		
26	142	137	133	129	125	119	109	96					137	133	128	124	120	116	103	89				26		
28	132	127	123	119	115	110	107	95	80	72			127	123	118	114	111	107	101	88	74			28		
30	122	118	114	111	107	102	99	94	80	71	59		118	114	110	106	103	99	95	87	74	64	55	30		
32	115	110	106	103	100	95	92	90	79	70	58	49,5	111	106	103	99	96	92	89	86	73	64	54	32		
34		103	99	96	93	89	86	84	79	69	58	49		100	96	93	90	86	83	81	73	63	53	34		
36		97	93	90	87	83	81	79	76	68	57	48,5		94	90	87	84	81	78	76	72	63	53	36		
38		91	88	85	82	78	76	74	71	67	57	48		88	85	82	79	76	73	71	68	63	53	38		
40			83	80	77	73	71	69	67	64	56	47,5			80	77	74	71	68	67	64	62	52	40		
44			74	72	69	65	63	62	59	57	55	47			72	69	66	64	61	59	57	55	51	44		
48				65	62	59	57	55	53	50	49	46				62	60	57	54	53	50	49,5	47	48		
52				59	56	53	51	49,5	47	45	44	41,5				57	54	51	49	47,5	45	44	42	39,5	52	
56					51	48	46	44,5	42,5	40	39	37					49,5	46,5	44	42,5	40,5	39,5	37,5	35,5	56	
60						43,5	41,5	40,5	38	36	35	33						42,5	40	38,5	36,5	35,5	33,5	31,5	60	
64						40	38	36,5	34,5	32,5	31,5	29,5						39	36,5	35	33	32	29,9	27,9	64	
68							35	33,5	31	29,2	28,2	26,3							33	32	29,6	28,7	26,7	24,9	68	
72							32	30,5	28,2	26,3	25,3	23,5							30,5	28,9	26,8	25,9	23,9	22,1	72	
76								27,8	25,7	23,7	22,7	20,9									26,5	24,3	23,3	21,4	19,6	76
80								25,7	23,4	21,4	20,4	18,6									24,3	22,1	21	19,2	17,4	80
84									21,4	19,3	18,3	16,5										20,1	19	17,1	15,3	84
88										17,5	16,4	14,6											17,1	15,3	13,5	88
92										15,9	14,7	12,9											15,5	13,6	11,8	92
96											13,1	11,3												12,1	10,3	96
100												11,8	9,9											10,7	8,9	100
104													8,6												7,6	104
108																									6,5	108

TAB 154454 / 154455 / 154456 / 154457

Traglasten am SW-Auslegersystem Lifting capacities on SW boom/jib combination Forces de levage en configuration SW

SW

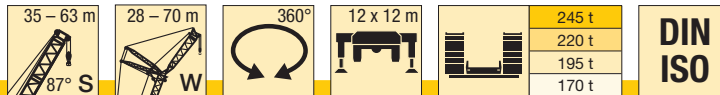

m	63 m							m
	28 m	35 m	42 m	49 m	56 m	63 m	70 m	
16	216							16
18	192	185	177					18
20	173	166	161	148				20
22	157	151	146	141	128			22
24	144	139	134	129	125	109	95	24
26	133	128	123	119	116	107	93	26
28	123	118	114	110	107	102	92	28
30	114	110	106	103	100	95	91	30
32	107	103	99	96	93	88	86	32
34		96	93	90	87	83	80	34
36		90	87	84	81	77	75	36
38		85	82	79	77	73	71	38
40			78	75	72	68	66	40
44			70	67	64	61	59	44
48				60	58	55	53	48
52				55	53	49	47,5	52
56					48	44,5	43	56
60						40,5	39	60
64						37	35,5	64
68							32	68
72							29,6	72

TAB 154454 / 154455 / 154456 / 154457

Hubhöhen am SW-Auslegersystem
Lifting heights on SW boom/jib combination
Hauteur de levage en configuration SW

SW

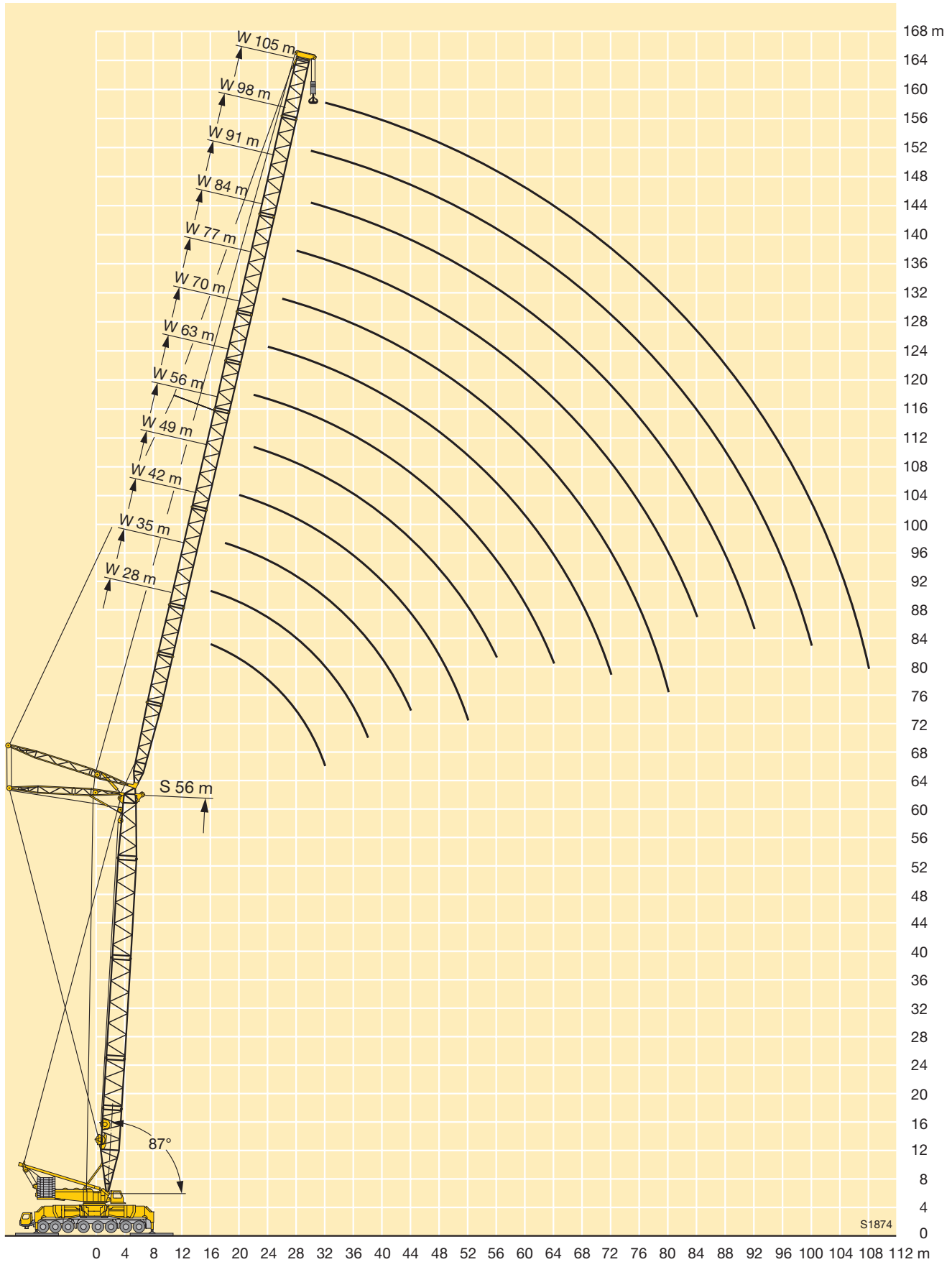

S1874

Traglasten am SW-Auslegersystem

Lifting capacities on SW boom/jib combination

Forces de levage en configuration SW

SW



35 – 63 m
77° S



28 – 105 m
W



360°



16 x 16 m



250 t
225 t
200 t
175 t

DIN ISO

m	35 m											42 m											m					
	28 m	35 m	42 m	49 m	56 m	63 m	70 m	77 m	84 m	91 m	98 m	105 m	28 m	35 m	42 m	49 m	56 m	63 m	70 m	77 m	84 m	91 m		98 m	105 m			
24	174																								24			
26	159												156													26		
28	147	145											143	142												28		
30	136	134	133										133	131												30		
32	126	124	124	122									123	122	121											32		
34	118	116	115	114									115	114	113	111										34		
36	110	109	108	106	106								107	106	106	104										36		
38	103	102	101	100	99	98							101	100	99	98	96									38		
40		96	95	94	93	92							94	93	92	91	89									40		
44		86	85	84	83	81	80	79					84	83	82	81	79	78								44		
48			76	75	74	73	71	71	70						75	73	72	71	70	69	68					48		
52				69	68	67	66	64	64	63	62	59			68	66	65	64	63	61	61	59				52		
56					62	61	60	58	58	57	56	55	49,5				60	59	57	56	55	54	53	52		56		
60						56	54	53	52	51	49,5	49	47				55	54	52	51	49,5	48,5	47	46,5	44,5	60		
64							51	49,5	48	47	46	44,5	44	42,5				49	47	46	44,5	43,5	42	41,5	40	64		
68								45	43,5	42,5	41,5	40,5	39,5	38				43	41,5	40	39,5	38	37	35,5	35,5	68		
72									41	39,5	38,5	37,5	36	35,5	34				39	38	36,5	35,5	34	33,5	31,5	72		
76										36	35	34	32,5	32	30,5					34,5	33	32	30,5	29,8	28,3	76		
80											32	31	29,7	28,7	27,4						31,5	29,9	29	27,5	26,6	25,2	80	
84												29,1	28,1	26,8	25,9	24,4						27,2	26,2	24,8	23,9	22,3	84	
88													25,5	24,1	23,4	21,9						24,6	23,7	22,2	21,4	19,8	88	
92														23,1	21,8	20,9	19,5						21,4	20	19,1	17,6	92	
96															19,7	18,7	17,3						17,9	16,9	15,5	96		
100																17,7	16,7	15,3					16	15	13,4	100		
104																	14,9	13,4							13,2	11,7	104	
108																										11,5	10,1	108
112																											8,5	112

TAB 154289 / 154290 / 154291 / 154464



35 – 63 m
77° S



28 – 105 m
W



360°



16 x 16 m



250 t
225 t
200 t
175 t

DIN ISO

m	49 m											56 m											m							
	28 m	35 m	42 m	49 m	56 m	63 m	70 m	77 m	84 m	91 m	98 m	105 m	28 m	35 m	42 m	49 m	56 m	63 m	70 m	77 m	84 m	91 m		98 m	105 m					
28	140																									28				
30	129	128												126													30			
32	120	119												117	116												32			
34	112	111	110											109	108												34			
36	105	104	102	102										102	101	100											36			
38	98	97	96	95										96	95	94	92										38			
40	93	91	90	89	88									90	89	88	87	85									40			
44		82	80	80	79	76									80	78	77	76	74								44			
48			73	72	71	70	68	67	66						71	70	69	67	65	64							48			
52				65	63	61	60	59	57	57						63	62	60	58	56	56	54				52				
56					58	57	55	53	53	51	49,5	48,5				57	55	54	52	50	49,5	48	47,5			56				
60						53	51	49,5	48	47	45,5	44	43,5	41			50	48,5	47	45	44	42,5	42	40,5		60				
64							46,5	45	43	42,5	41	39	38,5	37				44	42,5	40,5	39,5	38	37,5	36	34	64				
68								42,5	40,5	39	38	36,5	35	34,5	33				40	38,5	36,5	35,5	34	33	31,5	30	68			
72									37	35,5	34,5	33	31,5	30,5	28,9					34,5	33	32	30,5	29,7	27,9	26,3	72			
76										33,5	32	31	29,6	28,1	27,4	25,7					31,5	29,8	28,9	27,2	26,4	24,9	23,1	76		
80											29,2	28,2	26,8	25,2	24,3	22,8						27	25,9	24,5	23,5	22	20,3	80		
84												25,5	24	22,6	21,6	20,1							24,4	23,4	21,9	20,9	19,3	17,7	84	
88													23	21,6	20,2	19,2	17,5							21	19,5	18,6	16,9	15,2	88	
92														19,5	17,9	17	15,3								17,4	16,4	14,8	13,1	92	
96															17,4	16	14,9	13,3							15,5	14,4	12,8	11,1	96	
100																14,1	13	11,3								12,6	11	9,2	100	
104																		11,3	9,6							10,8	9,4	7,5	104	
108																			9,6	8,2							8	6,2	108	
112																												6,6	5,2	112
116																													4,2	116

TAB 154289 / 154290 / 154291 / 154464

Traglasten am SW-Auslegersystem

Lifting capacities on SW boom/jib combination

Forces de levage en configuration SW

SW

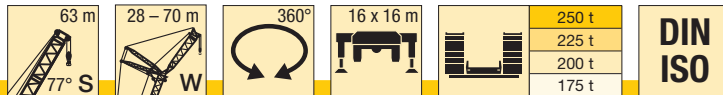

m	63 m							m
	28 m	35 m	42 m	49 m	56 m	63 m	70 m	
32	114							32
34	106	105						34
36	100	98						36
38	93	92	91					38
40	88	86	85	83				40
44	78	77	75	74	72			44
48		68	67	65	64	62		48
52			60	59	57	55	54	52
56			54	53	51	49		56
60				47,5	46	43,5	42,5	60
64				43	41,5	39,5	38	64
68					37,5	35,5	34	68
72					34	32	31	72
76						28,9	27,8	76
80							25	80
84							22,5	84

TAB 154289 / 154290 / 154291 / 154464

Hubhöhen am SW-Auslegersystem
Lifting heights on SW boom/jib combination
Hauteur de levage en configuration SW

SW

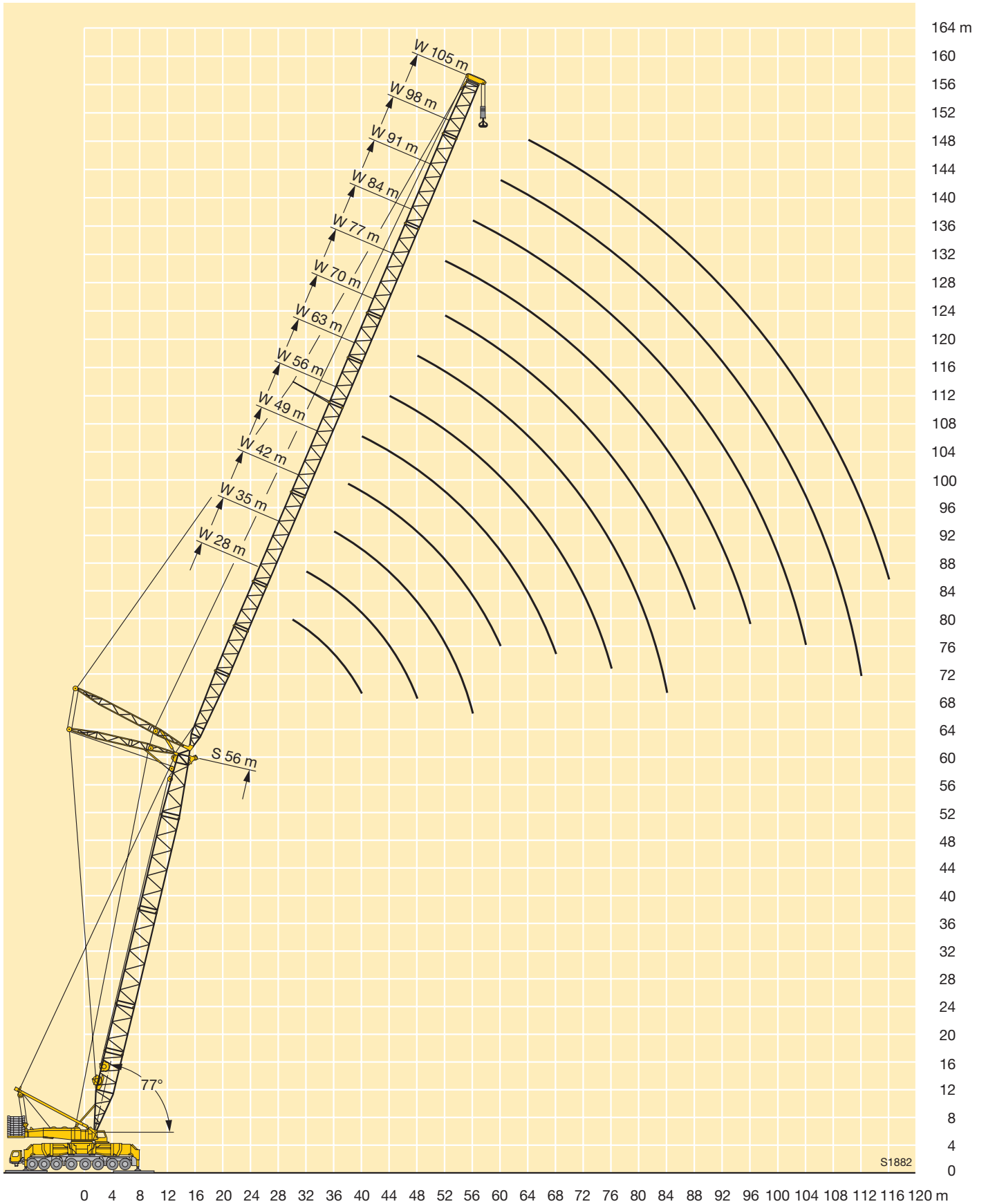

Traglasten am SW-Auslegersystem

Lifting capacities on SW boom/jib combination

Forces de levage en configuration SW

SW



35 – 63 m



28 – 105 m



360°



12 x 12 m



245 t

220 t

195 t

170 t

DIN

ISO

m	35 m											42 m											m		
	28 m	35 m	42 m	49 m	56 m	63 m	70 m	77 m	84 m	91 m	98 m	105 m	28 m	35 m	42 m	49 m	56 m	63 m	70 m	77 m	84 m	91 m		98 m	105 m
24	152																								24
26	139												131												26
28	127	123											120	116											28
30	118	113	110										111	107											30
32	109	105	102	98									103	99	96										32
34	102	98	95	91									97	93	90	86									34
36	95	92	89	85	83								91	87	84	80									36
38	88	87	83	80	78	74							85	81	79	75	72								38
40		81	79	75	73	70							77	74	71	68	65								40
44		71	70	67	65	62	59	57					69	66	63	60	57	55							44
48			62	60	58	55	52	50	48,5					60	56	54	51	49	46,5	45					48
52			55	54	52	49,5	46,5	45	43,5	41	40			54	51	48,5	45,5	43,5	41	39,5	37,5				52
56				48,5	47	44,5	41,5	40	38,5	36,5	35,5	33			46,5	43,5	41	39	36,5	35,5	33	32			56
60					43	40,5	37,5	36	34,5	32,5	31,5	29,3			42,5	40	37	35	33	31,5	29,4	28,3	26,2		60
64						38,5	36,5	34	32,5	31	29	27,9	25,9				36,5	33,5	31,5	29,5	28,2	26,1	25	23	64
68							33,5	31	29,3	27,9	25,9	24,8	22,9				30,5	28,7	26,5	25,2	23,1	22,1	20,2		68
72							30,5	28,1	26,5	25,1	23,1	22,1	20,2				28,2	26,1	23,8	22,5	20,5	19,5	17,6		72
76								25,8	24	22,6	20,6	19,6	17,7					23,8	21,5	20,1	18,2	17,2	15,3		76
80									21,9	20,4	18,4	17,4	15,5					21,8	19,4	18	16,1	15	13,2		80
84									20	18,4	16,4	15,3	13,5						17,6	16,1	14,2	13,1	11,3		84
88										16,6	14,6	13,5	11,7						16,2	14,4	12,5	11,4	9,6		88
92										15,1	13	11,8	10						13	10,9	9,8	8			92
96											11,6	10,3	8,5									9,6	8,4	6,6	96
100											10,5	9	7,2									8,4	7,1	5,2	100
104												7,8	5,9										5,9	4	104
108													4,8										4,9	2,9	108
112													3,8										2	2	112

TAB 154478 / 154479 / 154480 / 154481



35 – 63 m



28 – 105 m



360°



12 x 12 m



245 t

220 t

195 t

170 t

DIN

ISO

m	49 m											56 m											m			
	28 m	35 m	42 m	49 m	56 m	63 m	70 m	77 m	84 m	91 m	98 m	105 m	28 m	35 m	42 m	49 m	56 m	63 m	70 m	77 m	84 m	91 m		98 m	105 m	
28	112																								28	
30	104	100												97											30	
32	97	93												90	87										32	
34	90	87	83											84	81										34	
36	85	81	78	75										79	76	73									36	
38	80	76	73	71										74	71	68	65								38	
40	75	72	69	66	64									70	67	64	61	59							40	
44		64	61	59	56	53									60	57	54	52	49						44	
48		58	55	53	50	46,5	45	43							54	51	48,5	46	43,5	40,5					48	
52			50	47,5	45	41,5	40	38,5	36							46,5	43,5	41	38,5	36	34,5	32			52	
56				43	41	37,5	35,5	34	32	29,6	28,5					42,5	39,5	37	34,5	32	30,5	28,3	27,2		56	
60					39,5	37	33,5	32	30,5	28,2	26,1	25	23				36	33,5	31	28,5	27,1	24,9	23,8	21,7	60	
64						33,5	30,5	28,6	27,2	25,1	22,9	22	19,9					30,5	27,9	25,4	24,1	21,9	20,9	18,8	16,8	64
68						31	27,6	25,7	24,4	22,2	20,2	19,2	17,2					27,8	25,2	22,7	21,4	19,3	18,3	16,3	14,3	68
72							25,1	23,2	21,8	19,7	17,7	16,8	14,8						22,8	20,3	19	16,9	15,9	14	12	72
76							23,2	21	19,6	17,5	15,5	14,6	12,7						20,8	18,2	16,9	14,8	13,8	11,9	10	76
80								19,1	17,5	15,5	13,5	12,6	10,7							16,4	15	12,9	11,9	10	8,2	80
84									15,8	13,7	11,7	10,8	8,9							14,9	13,3	11,2	10,2	8,3	6,5	84
88									14,2	12,1	10,1	9,1	7,3								11,8	9,7	8,6	6,8	5	88
92										10,7	8,6	7,6	5,8									8,3	7,2	5,4	3,6	92
96										9,5	7,3	6,2	4,4									7,2	5,9	4,1	2,3	96
100											6,2	5	3,2										4,8	2,9		100
104												3,9	2,1											3,7		104
108													2,9													108

TAB 154478 / 154479 / 154480 / 154481

Traglasten am SW-Auslegersystem
Lifting capacities on SW boom/jib combination
Forces de levage en configuration SW

SW

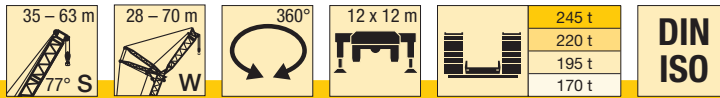

m	63 m							m
	28 m	35 m	42 m	49 m	56 m	63 m	70 m	
32	85							32
34	79	75						34
36	74	70						36
38	69	66	63					38
40	65	62	59	56				40
44	59	55	53	50	47,5			44
48		49,5	47	44,5	42,5	39		48
52			42,5	40	38	34,5	33	52
56			38,5	36	34	30,5	29	56
60				32,5	30,5	27,3	25,7	60
64				29,8	27,6	24,4	22,9	64
68					25,1	21,9	20,3	68
72					22,9	19,6	18,1	72
76						17,7	16	76
80							14,3	80
84							12,7	84

TAB 154478 / 154479 / 154480 / 154481

Hubhöhen am SW-Auslegersystem
Lifting heights on SW boom/jib combination
Hauteur de levage en configuration SW

SW

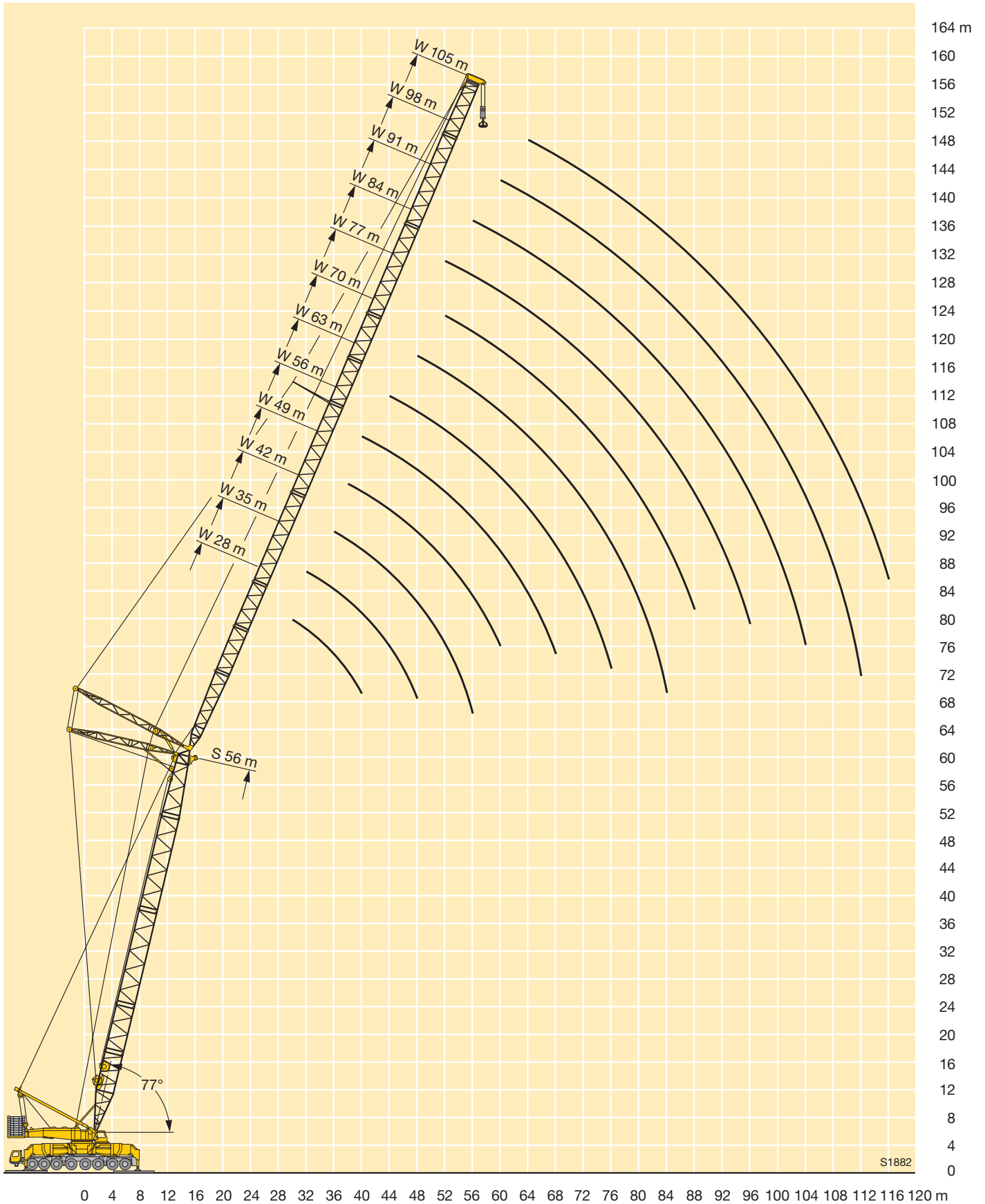

Traglasten am SW-Auslegersystem

Lifting capacities on SW boom/jib combination

Forces de levage en configuration SW

SW



35 – 63 m
67° S



28 – 105 m
W



360°



16 x 16 m



250 t
225 t
200 t
175 t



DIN
ISO

m	35 m										42 m										m			
	28 m	35 m	42 m	49 m	56 m	63 m	70 m	77 m	84 m	91 m	98 m	105 m	28 m	35 m	42 m	49 m	56 m	63 m	70 m	77 m		84 m	91 m	98 m
34	110																							34
36	104																							36
38	97	96																						38
40	92	90																						40
44	82	80	79																					44
48		72	70																					48
52			64	63	62																			52
56			59	57	56	55																		56
60				52	51	49	47,5																	60
64				47,5	46,5	44,5	43	41,5																64
68					42	40,5	38,5	37,5	36,5															68
72						38,5	36,5	35	34	33	31,5													72
76							33,5	32	30,5	29,6	28	27,1												76
80								28,9	27,7	26,6	25,1	24,1	22,5											80
84									26,2	25,1	24	22,5	21,5	19,8										84
88										22,6	21,6	20,1	19,1	17,4										88
92											20,4	19,4	17,9	16,8	15,2									92
96												17,3	15,9	14,8	13,2									96
100													15,4	14	12,9	11,3								100
104														12,3	11,1	9,6								104
108																								108
112													9,5	7,9										112
116														8										116
120																								120
124																								124

TAB 154327 / 154328 / 154329 / 154488

m	49 m										56 m										m			
	28 m	35 m	42 m	49 m	56 m	63 m	70 m	77 m	84 m	91 m	98 m	105 m	28 m	35 m	42 m	49 m	56 m	63 m	70 m	77 m		84 m	91 m	98 m
40	84																							40
44	75	67																						44
48	67	66	59																					48
52		59	58	51																				52
56			54	53	51	49,5																		56
60				48	46,5	44,5	42,5																	60
64					42	40,5	38,5	36,5																64
68						38	36,5	34,5	32,5	31,5														68
72							33	31	29,3	28,1	26,4													72
76								30	28,2	26,3	25,1	23,4	21,7											76
80									25,4	23,7	22,4	20,8	19	17,9										80
84										22,8	21,2	20	18,4	16,6	15,5	13,6								84
88											19	17,8	16,2	14,5	13,2	11,3								88
92												15,8	14,2	12,4	11,1	9,3								92
96													13,9	12,3	10,5	9,2	7,7							96
100														10,6	8,8	7,6	6,2							100
104															9	7,3	6,3	4,9						104
108																6,2	5,2	3,8						108
112																	5,2	4,1	2,8					112
116																		3,2						116

TAB 154327 / 154328 / 154329 / 154488

m	63 m						m
	28 m	35 m	42 m	49 m	56 m	70 m	
48	60						48
52	54	51					52
56		46,5	45				56
60		42	40,5	38,5			60
64			36,5	34,5	33		64
68			33	31,5	29,5	26,8	68
72				28,1	26,5	23,9	72
76					23,8	21,2	76
80						21,3	80
84							84
88							88
92							92
96							96

TAB 154327 / 154328 / 154329 / 154488

Hubhöhen am SW-Auslegersystem
Lifting heights on SW boom/jib combination
Hauteur de levage en configuration SW

SW

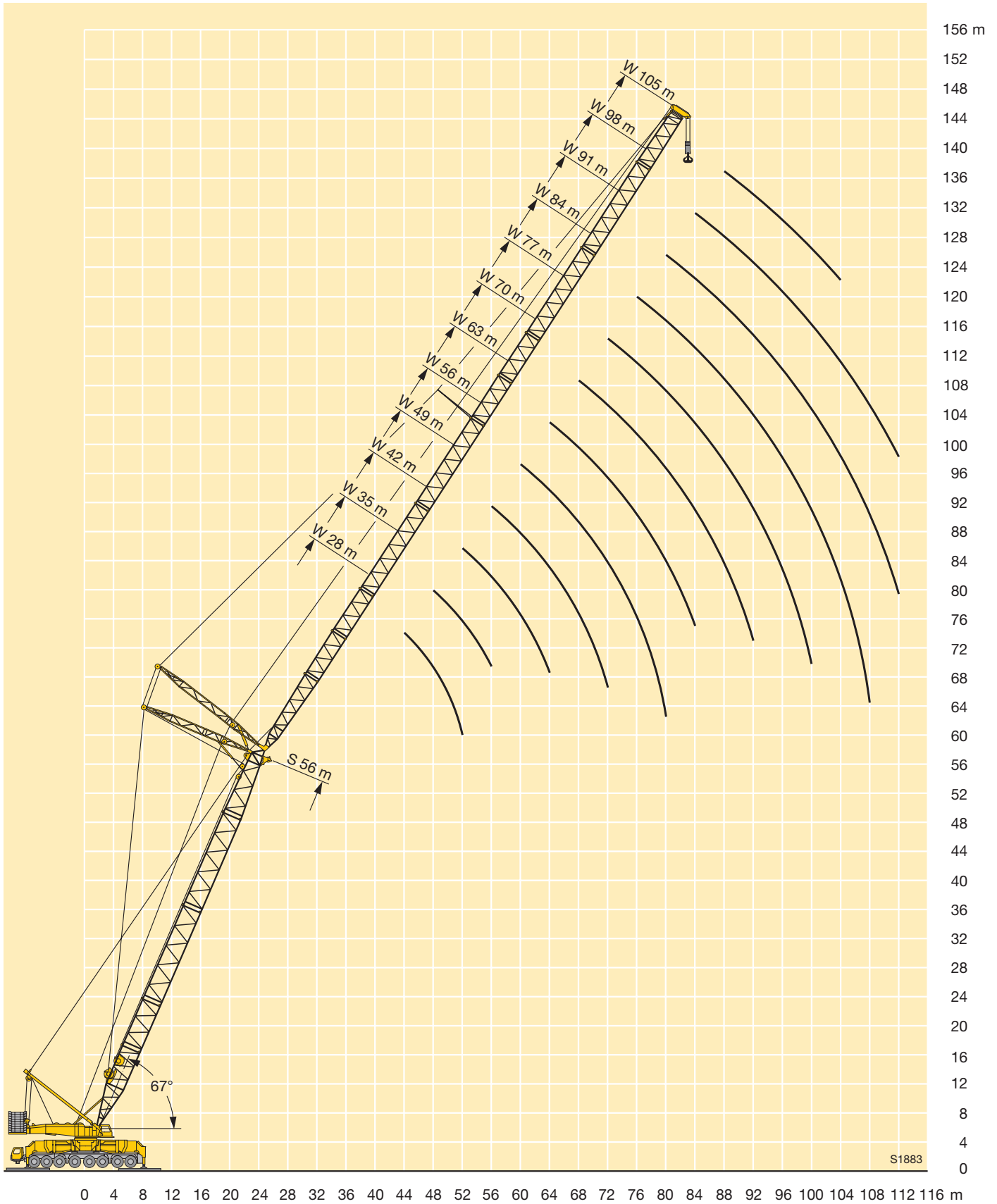

Traglasten am SW-Auslegersystem

Lifting capacities on SW boom/jib combination

Forces de levage en configuration SW

SW

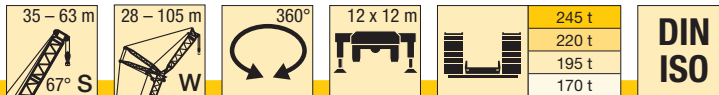

m	35 m										42 m										m				
	28 m	35 m	42 m	49 m	56 m	63 m	70 m	77 m	84 m	91 m	98 m	105 m	28 m	35 m	42 m	49 m	56 m	63 m	70 m	77 m		84 m	91 m	98 m	105 m
34	93																							34	
36	87																								36
38	81	77											74												38
40	75	73											70												40
44	66	64	62										62												44
48		57	56	52										59											48
52			49,5	47	45									48	45,5	42,5	40								52
56			44,5	42,5	40,5	38									41	38,5	36	33							56
60				39	37	34	31,5								38	34,5	32	29,6	27,7						60
64				35	33,5	30,5	28,1	26,5								31,5	29,1	26,5	24,6	22,3					64
68					30,5	27,8	25,2	23,6	22,3							29,3	26,4	23,8	21,9	19,6	18,3				68
72					27,6	25,3	22,7	21,1	19,7	17,7							24,2	21,4	19,5	17,3	16	13,9			72
76						23,2	20,4	18,8	17,4	15,4	14,4						19,3	17,4	15,2	13,9	11,8	10,8			76
80							18,5	16,8	15,4	13,4	12,3	10,5					17,6	15,6	13,3	12	10	9	7		80
84								16,9	15	13,6	11,6	10,5	8,7					13,9	11,7	10,3	8,3	7,3	5,4		84
88									13,5	11,9	10	8,9	7					12,6	10,2	8,8	6,8	5,8	3,9		88
92									12,2	10,5	8,5	7,4	5,5						8,9	7,4	5,4	4,4	2,5		92
96										9,2	7,2	6	4,2						8	6,2	4,2	3,1			96
100											8,2	6	4,7	2,9							5,2	3,1			100
104												5	3,6									2,1			104
108													2,6												108

TAB 154502 / 154503 / 154504 / 154505

m	49 m										56 m										m				
	28 m	35 m	42 m	49 m	56 m	63 m	70 m	77 m	84 m	91 m	98 m	28 m	35 m	42 m	49 m	56 m	63 m	70 m	77 m	84 m		91 m			
40	63																							40	
44	56	53																							44
48	50	47	44,5																						48
52		42,5	39,5	37,5																					52
56		38,5	36	33,5	31,5																				56
60			32,5	30,5	28,1	24,7																			60
64				27,5	25,2	21,9	20,1																		64
68				25	22,7	19,4	17,6	16,2																	68
72					20,5	17,2	15,5	14,1	11,9																72
76					18,7	15,3	13,5	12,1	10	8															76
80						13,7	11,8	10,4	8,3	6,3	5,3														80
84						12,4	10,3	8,8	6,8	4,8	3,8														84
88							9	7,4	5,4	3,4	2,4														88
92								6,2	4,1	2,1															92
96								5,1	3																96
100									2																100

TAB 154502 / 154503 / 154504 / 154505

m	63 m						m	
	28 m	35 m	42 m	49 m	56 m	70 m		
48	39						48	
52	35	32					52	
56		28,5	26,2				56	
60		25,7	23,3	20,9			60	
64			20,9	18,4	16,4		64	
68			18,9	16,3	14,4	11,1	68	
72				14,5	12,5	9,3	7,8	72
76				13	10,9	7,7	6,2	76
80					9,5	6,3	4,8	80
84						5,1	3,5	84
88						4	2,3	88

TAB 154502 / 154503 / 154504 / 154505

Hubhöhen am SW-Auslegersystem
Lifting heights on SW boom/jib combination
Hauteur de levage en configuration SW

SW

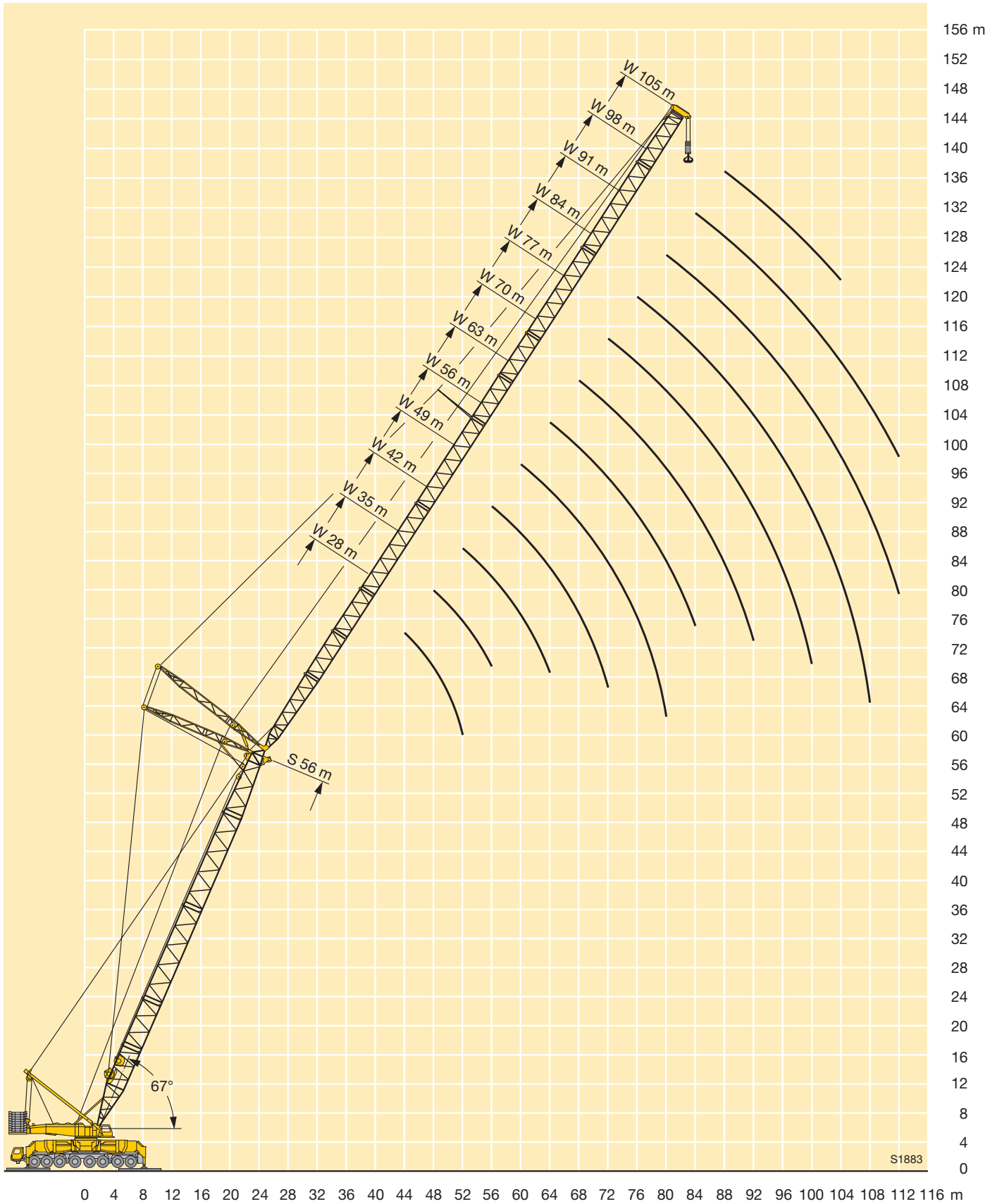

S1883

Traglasten am SDW-Auslegersystem

Lifting capacities on SDW boom/derrick combination

Forces de levage en configuration SDW

SDW

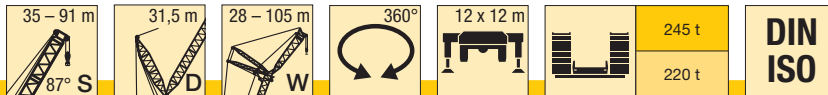

m	35 m											42 m											m			
	28 m	35 m	42 m	49 m	56 m	63 m	70 m	77 m	84 m	91 m	98 m	105 m	28 m	35 m	42 m	49 m	56 m	63 m	70 m	77 m	84 m	91 m		98 m	105 m	
14	286												285												14	
16	242	241											241	240											16	
18	209	208	207										208	207	207										18	
20	183	182	182	181	181								183	182	181	180									20	
22	163	162	161	161	160	158							162	161	161	159	158	151							22	
24	146	145	144	144	143	142	135						146	145	144	143	142	141	129						24	
26	133	131	130	130	129	128	125	113					132	131	130	129	128	126	124	106					26	
28	121	119	119	118	117	116	114	111	94				120	119	118	117	116	115	114	105	89				28	
30	111	109	109	108	107	105	103	103	94	80	67		110	109	108	107	106	104	104	102	89	76			30	
32		101	100	99	98	97	95	94	92	79	66	56		100	100	98	97	96	95	93	88	75	62		32	
34		93	92	91	90	89	87	87	87	78	66	55		93	92	91	89	88	87	86	86	74	62	52	34	
36		87	86	85	83	82	80	80	80	77	65	55		86	85	84	83	81	81	79	79	73	61	52	36	
38			80	79	78	76	74	74	74	72	64	55		80	80	78	77	75	75	73	73	71	61	51	38	
40			74	73	72	71	69	68	68	67	63	54			74	73	71	70	69	68	67	66	60	51	40	
44			66	64	63	62	60	59	59	57	58	52			65	64	62	61	60	59	58	57	56	50	44	
48				57	56	54	52	52	51	50	50	48,5				56	55	53	53	51	51	49	49	47	48	
52				49,5	47,5	46	45,5	45	43,5	43	41,5						48,5	47	46	44,5	44	42,5	42,5	41	52	
56				44	42,5	40,5	40	39	37,5	37,5	36						43,5	42	41	39	38,5	37	37	35,5	56	
60					37,5	36	35	34,5	33	32,5	31							37	36	34,5	34	32,5	32	30,5	60	
64					33,5	32	31	30,5	28,7	28,3	26,8							33	32	30,5	29,7	28,1	27,7	26,1	64	
68						28,4	27,4	26,6	25,1	24,6	23								28,4	26,8	26	24,5	24	22,3	68	
72							24,3	23,4	21,8	21,2	19,6									23,7	22,8	21,2	20,6	19	72	
76							21,5	20,5	18,9	18,2	16,6									20,9	20	18,3	17,6	16	76	
80								17,9	16,3	15,6	14,2										17,4	15,7	15,1	13,7	80	
84									14,3	13,6	12,3											15,2	13,8	13,2	11,9	84
88									12,6	11,9	10,6											12,2	11,5	10,2	8,8	88
92											10,4	9,1											10	8,7	9,2	92
96											9	7,7											8,7	7,4	9,6	96
100												6,5											6,1	6,1	100	

TAB 154414 / 154415

m	49 m											56 m											m					
	28 m	35 m	42 m	49 m	56 m	63 m	70 m	77 m	84 m	91 m	98 m	105 m	28 m	35 m	42 m	49 m	56 m	63 m	70 m	77 m	84 m	91 m		98 m	105 m			
14	265																								14			
16	240	240												238											16			
18	207	207	207											207	204	197									18			
20	182	181	181	179										181	181	178	171								20			
22	162	161	161	160	158									161	160	159	156	151							22			
24	145	144	144	143	142	137								145	144	143	141	138	130						24			
26	131	130	130	129	128	125	118	100						131	130	129	128	127	123	110					26			
28	120	119	118	117	116	114	113	99	83					119	118	117	116	115	114	108	92	78			28			
30	110	109	108	107	106	104	103	98	83	71				109	108	107	106	105	104	102	91	78	66		30			
32		100	100	98	97	95	94	94	83	71	59			101	100	99	97	96	95	93	90	77	66	55	32			
34		93	92	91	90	87	87	87	82	70	58	49,5			92	91	90	89	88	86	86	77	66	55	46	34		
36		86	85	84	83	81	80	80	78	69	58	49			86	84	83	82	81	79	79	75	65	54	45,5	36		
38		80	79	78	77	75	74	74	72	69	57	49			80	79	77	76	75	73	73	71	65	54	45,5	38		
40			74	73	72	69	68	68	67	65	56	48,5				73	72	71	70	68	68	66	64	53	45	40		
44			65	64	63	60	59	58	56	54	47					64	63	62	61	59	59	57	57	52	44,5	44		
48				56	55	53	52	52	50	48,5	48,5	45					56	54	53	51	51	49,5	49,5	48	43,5	48		
52					49	46,5	45,5	45	43,5	42	42	40,5						48	46,5	45	44,5	43	43	41	39,5	52		
56					43,5	41	40	39,5	38	36,5	36,5	34,5						42,5	41,5	39,5	39	37,5	37	35,5	34	56		
60						36,5	35,5	35	33	31,5	31,5	29,8								36,5	35	34	32,5	32,5	30,5	29	60	
64						32,5	31,5	30,5	29,1	27,5	27,1	25,5								32,5	30,5	30	28,4	28,1	26,4	24,7	64	
68							27,9	27,1	25,5	23,8	23,4	21,7										27,2	26,5	24,8	24,4	22,7	20,9	68
72								23,9	22,3	20,6	20	18,3										23,3	21,6	21,1	19,3	17,5	72	
76								21,1	19,4	17,7	17	15,4										20,5	18,7	18,1	16,3	14,7	76	
80									16,8	15,2	14,6	13,2											16,2	15,5	14	12,7	80	
84									14,8	13,3	12,7	11,4											14,2	13,6	12,2	10,9	84	
88										11,8	11,1	9,8											12	10,6	9,3	8,8	88	
92												9,6	8,3											9,2	7,8	9,2	92	
96												8,3	7											7,9	7,4	9,6	96	
100													5,8												5,4	100		
104																									4,3	104		

TAB 154414 / 154415

Traglasten am SDW-Auslegersystem

Lifting capacities on SDW boom/derrick combination

Forces de levage en configuration SDW

SDW

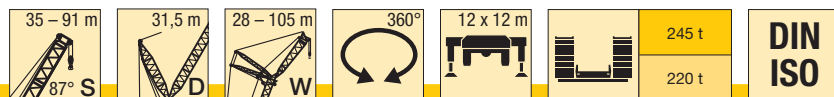

m	63 m										70 m										m			
	28 m	35 m	42 m	49 m	56 m	63 m	70 m	77 m	84 m	91 m	98 m	105 m	28 m	35 m	42 m	49 m	56 m	63 m	70 m	77 m		84 m	91 m	98 m
16	227											216												16
18	203	196										194	187											18
20	180	177	170	165								175	169	162										20
22	160	160	155	150	140							159	154	148	143									22
24	144	143	142	138	133	119						142	142	136	131	125	108							24
26	130	129	128	127	123	117	100					129	129	125	121	118	106	91						26
28	118	118	117	116	114	109	100	85				117	117	115	112	109	104	91	78					28
30	108	108	107	106	105	101	99	84	72			108	107	105	104	102	97	90	78	66				30
32	100	99	98	97	96	94	92	83	71	61	51	99	99	97	95	95	90	88	77	66	56			32
34		92	91	89	89	86	86	82	71	61	51		91	89	88	87	85	82	77	66	56	46,5		34
36		85	84	83	82	80	79	78	70	61	50	42,5	85	83	81	81	78	77	74	65	56	46,5	39	36
38		79	78	77	76	74	73	72	69	60	50	42	79	77	76	75	72	72	70	64	55	46	39	38
40			73	72	71	69	68	66	65	60	49,5	42		72	71	70	67	67	65	63	55	45,5	38,5	40
44			64	63	62	60	59	58	56	56	49	41		63	62	61	59	58	56	57	53	45	38	44
48				55	54	52	50	48	48	48,5	46	40,5			54	53	51	50	49	49	47,5	43	37,5	48
52				49	48	46	45	43,5	42	42	40	38			48	47	45	44	42,5	42,5	40,5	39	35,5	52
56					42,5	40,5	39,5	38	36,5	36	34,5	33				41,5	39,5	38,5	37	37	35	33,5	31,5	56
60						36	35	33,5	31,5	31,5	29,7	28					35	34	32,5	32	30,5	28,6	26,9	60
64						32	31	29,2	27,5	27,2	25,5	23,7					31	29,9	28,3	27,9	26,2	24,4	22,6	64
68							27,3	25,7	23,9	23,5	21,7	19,9						26,4	24,7	24,2	22,5	20,7	18,8	68
72							24,2	22,5	20,7	20,2	18,4	16,5						23,3	21,6	21	19,2	17,3	15,5	72
76								19,7	17,9	17,2	15,5	13,9							18,8	18,1	16,3	14,6	13,1	76
80									15,4	14,8	13,3	12								15,6	14	12,6	11,2	80
84									13,6	13	11,6	10,2								13,7	12,3	10,9	9,5	84
88										11,4	10	8,7									10,8	9,4	8	88
92											8,6	7,3									9,4	8	6,6	92
96											7,4	6										6,8	5,4	96
100												4,8											4,2	100
104												3,8											3,2	104

TAB 154414 / 154415

m	77 m										84 m										m			
	35 m	42 m	49 m	56 m	63 m	70 m	77 m	84 m	91 m	98 m	105 m	42 m	49 m	56 m	63 m	70 m	77 m	84 m	91 m	98 m		105 m		
18	178																							18
20	161	154																						20
22	147	142	132																					22
24	135	131	126	112																				24
26	125	121	117	111	97																			26
28	115	112	109	104	96	83	71																	28
30	105	104	101	97	94	82	71	61																30
32	97	96	95	91	87	82	70	60	51															32
34	90	89	88	85	82	78	69	60	51	38														34
36	83	82	81	79	77	74	68	59	51	38	32													36
38	77	76	75	73	72	69	66	59	50	37,5	32													38
40		71	70	68	67	65	62	58	50	37,5	32													40
44		63	62	60	59	57	55	54	49	37	31,5													44
48			54	52	51	49	47,5	47,5	46	36	31													48
52			48	46	45	43	41	41	39,5	34	30,5													52
56				40,5	39,5	37,5	36	35,5	34	28,9	28,8													56
60					35	33	31	31	29,2	24,6	25,3													60
64						28,9	27,2	26,8	25	20,9	21,3													64
68						25,4	23,6	23,2	21,3	17,5	17,7													68
72						22,3	20,5	19,9	18	14,5	14,5													72
76							17,7	17	15,3	12,3	12,2													76
80								14,7	13,2	10,6	10,4													80
84								12,9	11,5	9,1	8,9													84
88									10	7,8	7,5													88
92									8,7	6,6	6,2													92
96										5,5	5,1													96
100											4													100
104											3,1													104

TAB 154414 / 154415

Traglasten am SDW-Auslegersystem
Lifting capacities on SDW boom/derrick combination
Forces de levage en configuration SDW

SDW

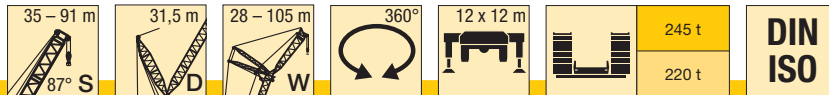

m	91 m									m
	49 m	56 m	63 m	70 m	77 m	84 m	91 m	98 m	105 m	
22	103									22
24	102	89								24
26	100	89	77							26
28	99	88	77	67						28
30	93	85	75	66	57					30
32	87	83	74	66	56	43,5				32
34	82	78	72	64	56	43	36,5	29,5		34
36	77	73	69	63	56	43	36,5	29,2	22,9	36
38	72	69	65	62	55	42,5	36	28,9	22,9	38
40	68	65	62	60	54	42	36	28,6	22,8	40
44	60	58	55	53	51	41	35,5	28,3	22,4	44
48	53	51	48	48	45,5	38,5	34,5	27,9	21,9	48
52	46,5	44,5	42	41,5	40	34,5	32,5	27,2	21,5	52
56		39	37	36,5	34,5	29,5	27,9	25,9	21,1	56
60		34,5	32,5	32	30	25,3	23,7	22,9	19,9	60
64			28,5	27,8	26	21,7	20	19,2	16,4	64
68				24,3	22,5	18,5	16,6	15,9	13,2	68
72				21,2	19,3	15,6	13,8	13,1	10,9	72
76					16,5	13,2	11,8	11,1	9,2	76
80					14,4	11,6	10,3	9,5	7,8	80
84						10,1	8,8	8,1	6,5	84
88							7,6	6,9	5,3	88
92							6,4	5,7	4,3	92
96								4,7	3,3	96
100									2,4	100

TAB 154414 / 154415

Hubhöhen am SDW-Auslegersystem
Lifting heights on SDW boom/derrick combination
Hauteur de levage en configuration SDW

SDW

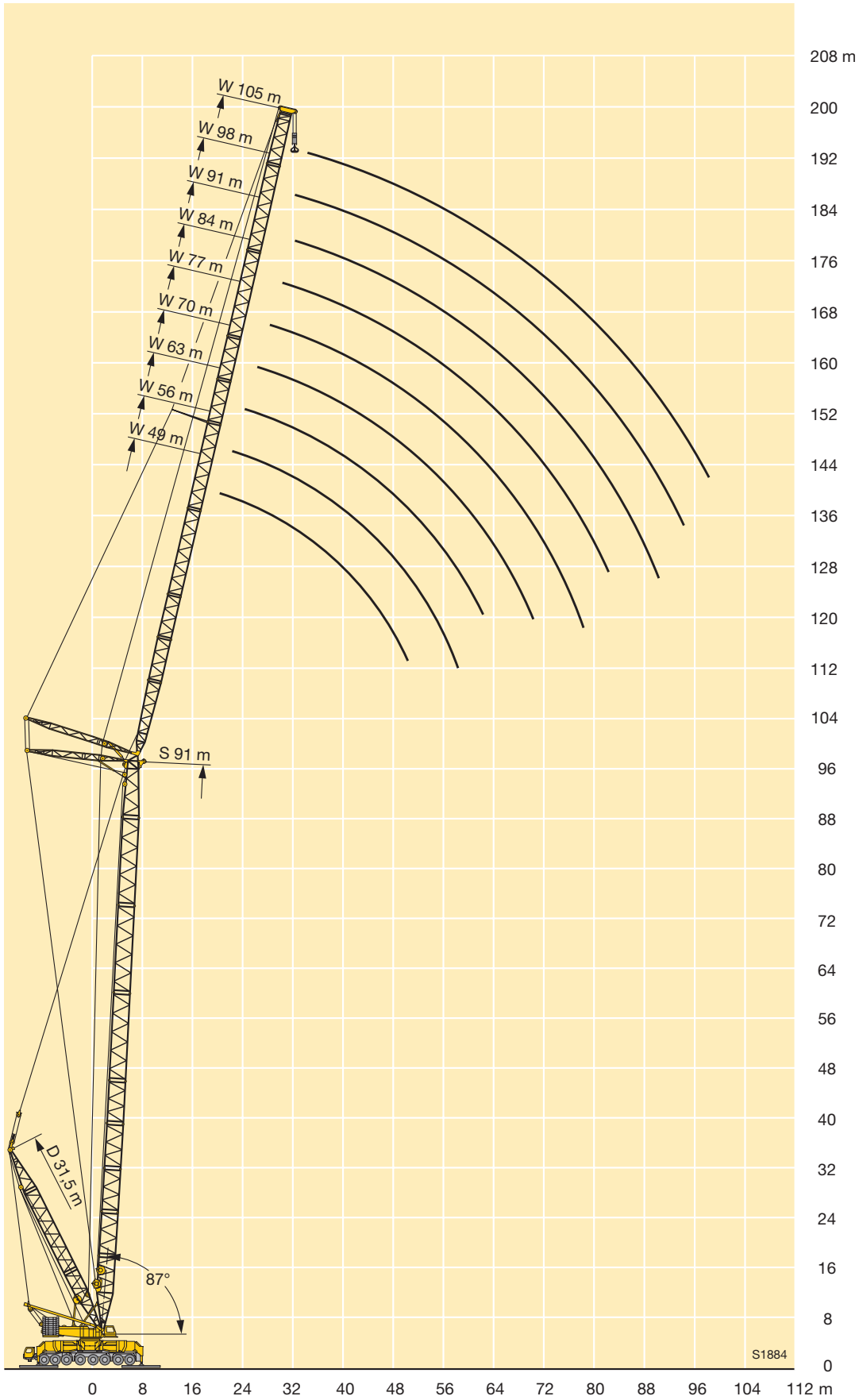

Traglasten am SDW-Auslegersystem

Lifting capacities on SDW boom/derrick combination

Forces de levage en configuration SDW

SDW

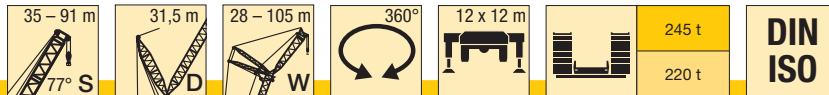

m	35 m											42 m											m			
	28 m	35 m	42 m	49 m	56 m	63 m	70 m	77 m	84 m	91 m	98 m	105 m	28 m	35 m	42 m	49 m	56 m	63 m	70 m	77 m	84 m	91 m		98 m	105 m	
24	133																								24	
26	121												117													26
28	110	108											106													28
30	101	99	98										97	96												30
32	93	91	90										90	88	87											32
34	86	84	83	82									83	81	80	78										34
36	79	78	77	75	74								77	75	74	72										36
38		72	71	70	68	67							71	70	69	67	65									38
40		68	66	65	64	62							65	64	62	61	59									40
44			58	57	55	54	52	51					57	56	54	53	51	50								44
48			51	50	48,5	46,5	44,5	44	43						49,5	47,5	46	44	43	41						48
52				44	42,5	41	39	38	37,5	35,5					43,5	42	40,5	38,5	37,5	35,5	34,5	33				52
56					39,5	37,5	36	34	33	32	30,5	30	28,2			37	35,5	33,5	32,5	30,5	29,8	27,9	27,4			56
60						33,5	31,5	29,6	28,6	27,8	26,1	25,5	23,7				31,5	29,5	28,2	26,4	25,5	23,6	23,1	21,1		60
64							27,9	25,9	24,9	24	22,2	21,6	19,7				27,8	25,9	24,5	22,7	21,8	19,9	19,2	17,2		64
68							24,7	22,7	21,6	20,6	18,8	18,1	16,2				22,7	21,3	19,4	18,5	16,6	15,9	14,2			68
72								19,8	18,6	17,6	15,8	15,2	13,6						18,5	16,6	15,6	14	13,4	11,9		72
76								17,4	16,1	15,1	13,6	13	11,6						16	14,3	13,5	12	11,4	9,9		76
80									14,1	13,2	11,8	11,1	9,7							12,6	11,7	10,3	9,6	8,2		80
84										11,5	10,1	9,4	8,1							11,1	10,1	8,7	8	6,6		84
88											10,1	8,7	7,9	6,6							8,7	7,3	6,6	5,2		88
92												7,4	6,6	5,2								6,1	5,3	3,9		92
96													6,2	5,4	4								4,9	4,1	2,7	96
100														4,2	2,9								3			100
104																								2,1		104

TAB 154416 / 154417

m	49 m											56 m											m			
	28 m	35 m	42 m	49 m	56 m	63 m	70 m	77 m	84 m	91 m	98 m	105 m	28 m	35 m	42 m	49 m	56 m	63 m	70 m	77 m	84 m	91 m		98 m	105 m	
28	103																								28	
30	94	92												91												30
32	86	85												83	82											32
34	80	78	77											77	75											34
36	74	72	71	70										71	70	68										36
38	69	67	66	65										66	65	63	61									38
40	64	63	62	60	58									62	60	59	57									40
44		55	54	52	51	48								52	51	49	47,5	46								44
48			47,5	45,5	44	41,5	40	39,5						46	44,5	42,5	41,5	39,5	37,5							48
52			42	40	38,5	36	34,5	34	32						39	37,5	36	34	32	31	29					52
56				35,5	34	31	29,9	29,1	27,2	25,2	24,7					33	31,5	29,5	27,3	26,3	24,4	23,7				56
60				31,5	29,7	27,1	25,8	24,9	23	21	20,4	18,2				29	27,3	25,5	23,3	22,3	20,3	19,5	17,4			60
64					26,2	23,6	22,2	21,3	19,3	17,3	16,6	14,7					23,9	22	19,8	18,8	16,7	15,9	14,1	12,4		64
68						20,5	19,1	18,1	16,1	14,4	13,7	12,2					21	19	16,7	15,7	14	13,3	11,8	10,2		68
72						17,9	16,3	15,3	13,7	12,2	11,6	10,1						16,3	14,3	13,4	11,9	11,2	9,7	8,2		72
76						14,2	13,3	11,8	10,3	9,7	8,2								12,5	11,6	10,1	9,4	7,9	6,4		76
80								11,6	10,1	8,7	8	6,5							10,9	10	8,5	7,8	6,3	4,8		80
84								10,1	8,6	7,2	6,5	5								8,6	7,1	6,3	4,9	3,4		84
88									7,3	5,8	5,1	3,7								7,3	5,8	5	3,6	2,1		88
92									6,1	4,6	3,9	2,5									4,7	3,9	2,4			92
96										3,6	2,8												2,8			96

TAB 154416 / 154417

Traglasten am SDW-Auslegersystem

Lifting capacities on SDW boom/derrick combination

Forces de levage en configuration SDW

SDW

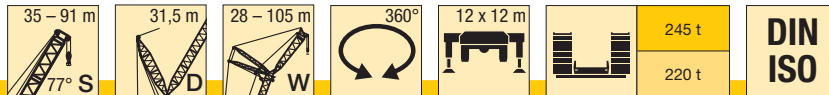

m	63 m											70 m											m			
	28 m	35 m	42 m	49 m	56 m	63 m	70 m	77 m	84 m	91 m	98 m	105 m	28 m	35 m	42 m	49 m	56 m	63 m	70 m	77 m	84 m	91 m		98 m	105 m	
32	79																								32	
34	73	72										70														34
36	68	66										64	63													36
38	63	62	60									60	58	56												38
40	58	57	56	54								55	54	52												40
44		50	48,5	46,5	45							48	47	44,5	43	41,5										44
48		43,5	42	40,5	39	36	35						41	38,5	37	35,5	32,5									48
52			37	35	33,5	31	29,7	27,6						33,5	32	30,5	27,4	26,2								52
56			32,5	30,5	29,2	26,4	25,2	23,1	20,9					29,4	27,6	26,1	23,1	21,8	19,5	18,7						56
60				26,9	25,3	22,6	21,3	19,1	16,9	16,1	14,2				24	22,3	19,4	18	15,7	15	13,1					60
64					22	19,2	17,8	15,7	13,9	13,2	11,6	10			20,8	19,1	16,1	14,9	13,1	12,4	10,8	9,1	7,4			64
68					19,1	16,3	15	13,3	11,7	11,1	9,5	7,8				16,3	13,7	12,7	11	10,4	8,7	7,1	5,4			68
72						14,1	12,9	11,4	9,8	9,1	7,6	6					11,9	10,8	9,2	8,5	6,9	5,4	3,7			72
76						12,4	11,2	9,6	8,1	7,4	5,9	4,3					10,3	9,2	7,6	6,9	5,3	3,8	2,2			76
80							9,7	8,1	6,6	5,9	4,4	2,8						7,8	6,2	5,5	3,9	2,4				80
84								6,8	5,3	4,5	3,1							6,5	4,9	4,2	2,7					84
88								5,6	4,1	3,3									3,8	3						88
92									3	2,2										2						92
96									2,1																	96

TAB 154416 / 154417

m	77 m											84 m											91 m											m
	35 m	42 m	49 m	56 m	63 m	70 m	77 m	84 m	91 m	98 m	105 m	42 m	49 m	56 m	63 m	70 m	77 m	84 m	91 m	98 m	49 m	56 m	63 m	70 m	77 m	84 m	91 m							
38	54																										38							
40	50	48,5																									40							
44	43	41,5	39,5									38															44							
48	37	35,5	34	31,5								32,5	29,8	28,3							26,3						48							
52	32,5	31	29,1	26,5	24,7	22						28,1	25,2	23,7	20,3						21,9	18,8	15,3				52							
56		26,8	25	22,4	20,5	17,7	15,4					24,2	21,2	19,6	16,2	13,8	13				18	15,2	12,4	11,4			56							
60			21,5	18,8	16,8	14,5	12,6	11,9	10,1			20,8	17,8	16,1	13,4	11,4	10,6	8,9			14,9	12,7	10,2	9,2	7,4		60							
64			18,4	15,7	14	12,1	10,4	9,7	8	6,3		15	13,6	11,3	9,4	8,6	6,9	5,1			12,8	10,7	8,4	7,4	5,6	3,8	2	64						
68				13,6	12	10,2	8,5	7,8	6,1	4,5	3,9		13,1	11,8	9,5	7,6	6,8	5,2	3,4	2,9	11,1	9	6,7	5,7	4	2,3		68						
72				11,9	10,3	8,5	6,8	6,1	4,5	2,9	2,3		10,2	7,9	6	5,3	3,6				7,6	5,3	4,3	2,6				72						
76					8,8	7	5,3	4,6	3					6,5	4,7	3,9	2,3				6,3	4	3					76						
80						5,7	4	3,3						5,3	3,5	2,6							2,9					80						
84						4,5	2,9	2,1							2,4													84						

TAB 154416 / 154417

Hubhöhen am SDW-Auslegersystem
Lifting heights on SDW boom/derrick combination
Hauteur de levage en configuration SDW

SDW

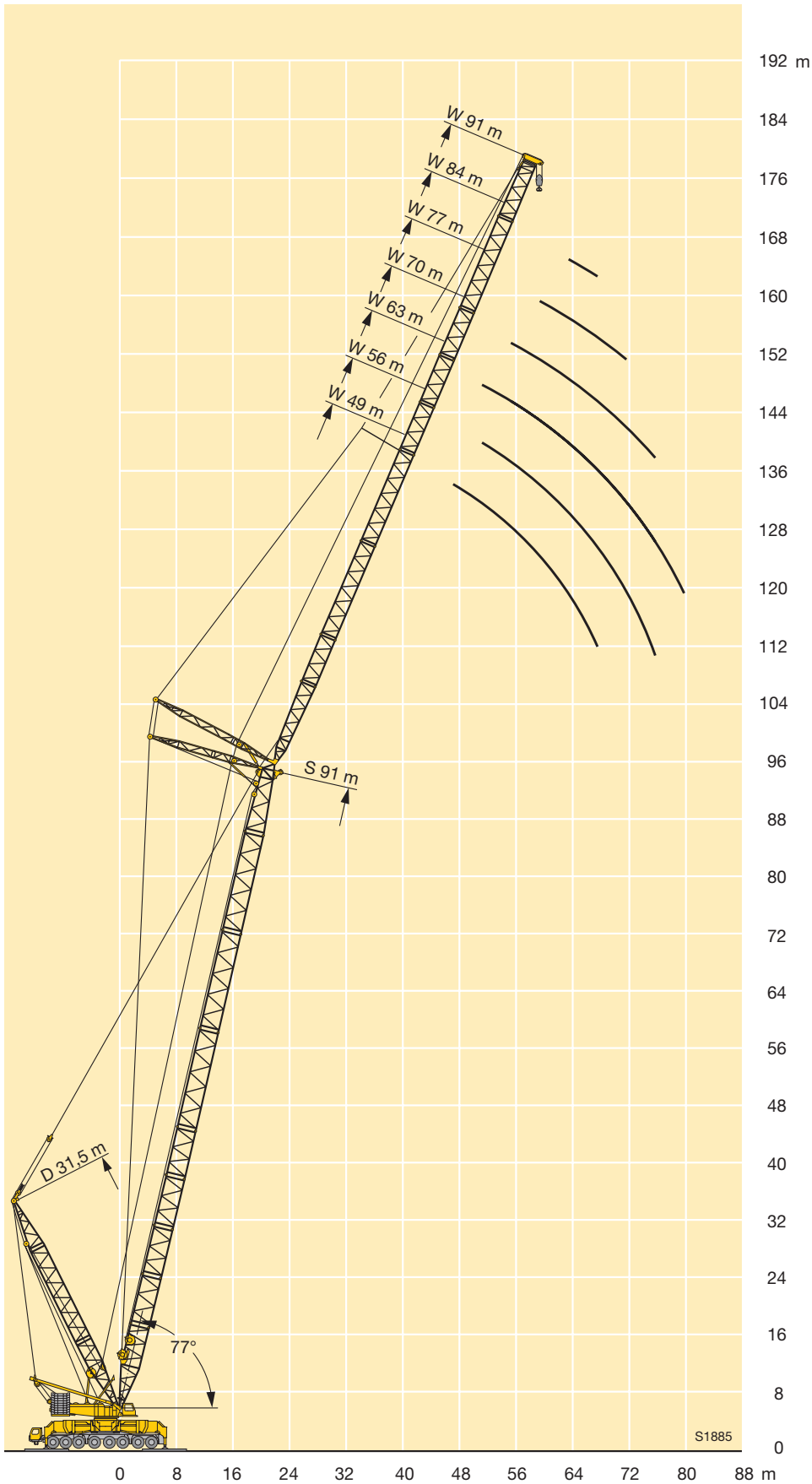

Traglasten am SDW-Auslegersystem

Lifting capacities on SDW boom/derrick combination

Forces de levage en configuration SDW

SDW

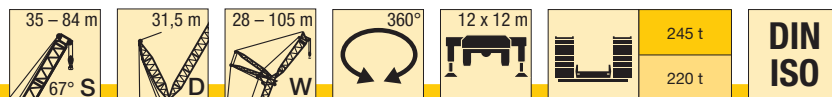

m	35 m										42 m										m				
	28 m	35 m	42 m	49 m	56 m	63 m	70 m	77 m	84 m	91 m	98 m	105 m	28 m	35 m	42 m	49 m	56 m	63 m	70 m	77 m		84 m	91 m	98 m	105 m
34	75																							34	
36	72																								36
38	67	63										62													38
40	62	60										58													40
44		53	51									51	48,5												44
48		46,5	45	44									42,5	41,5											48
52			39,5	38,5	36,5								37,5	36	34,5										52
56			35	34	32	30								32	30	28,4									56
60				29,9	27,9	26,2	23,6								26,4	24,6	22,2								60
64				24,5	22,7	20,2	19								23,2	21,3	18,9	17,3							64
68				21,6	19,7	17,2	15,9	15								18,5	16,1	14,7	12,9	11					68
72					17	14,8	13,7	12,8	11,3						16	13,9	12,6	11	10,1	7,3					72
76					14,8	12,9	11,8	10,9	9,4	8,7						12,2	10,9	9,3	8,4	6,8	5,3				76
80						11,3	10,2	9,3	7,8	7,1	5,6						9,4	7,8	6,9	5,3	4,6	3			80
84							8,8	7,8	6,3	5,6	4,1						8	6,5	5,5	4	3,2				84
88							7,5	6,5	5	4,2	2,8							5,3	4,3	2,8	2				88
92								5,3	3,9	3									4,2	3,2					92
96									2,8											2,2					96

TAB 154418 / 154419

m	49 m										56 m								m					
	28 m	35 m	42 m	49 m	56 m	63 m	70 m	77 m	84 m	91 m	28 m	35 m	42 m	49 m	56 m	63 m	70 m	77 m		84 m				
40	53																							40
44	46,5	58																						44
48	40,5	39	32,5																					48
52		34	32,5	26,4																				52
56			28,5	26,4	21,1																			56
60			25	22,9	21,1	15,1																		60
64				19,8	17,9	15,1	11,6																	64
68				17,2	15,3	12,9	11,6	10,6																68
72					13,4	11,1	9,8	8,8	7,3															72
76						9,5	8,3	7,2	5,7	4,1														76
80						8,2	6,9	5,8	4,3	2,7														80
84							5,6	4,6	3															84
88							4,5	3,4																88
92								2,4																92

TAB 154418 / 154419

m	63 m							70 m					77 m				84 m	m						
	28 m	35 m	42 m	49 m	56 m	63 m	70 m	28 m	35 m	42 m	49 m	56 m	63 m	35 m	42 m	49 m	56 m		49 m					
48	32																							48
52	27,5	26,1																						52
56		22,4	20,2																					56
60		19,2	17	14,9																				60
64			14,6	12,7	11,3																			64
68				11	9,5	7,1																		68
72				9,5	8	5,6	4,4																	72
76					6,6	4,3	3,1																	76
80					5,4	3,1																		80
84						2,1																		84

TAB 154418 / 154419

Hubhöhen am SDW-Auslegersystem
Lifting heights on SDW boom/derrick combination
Hauteur de levage en configuration SDW

SDW

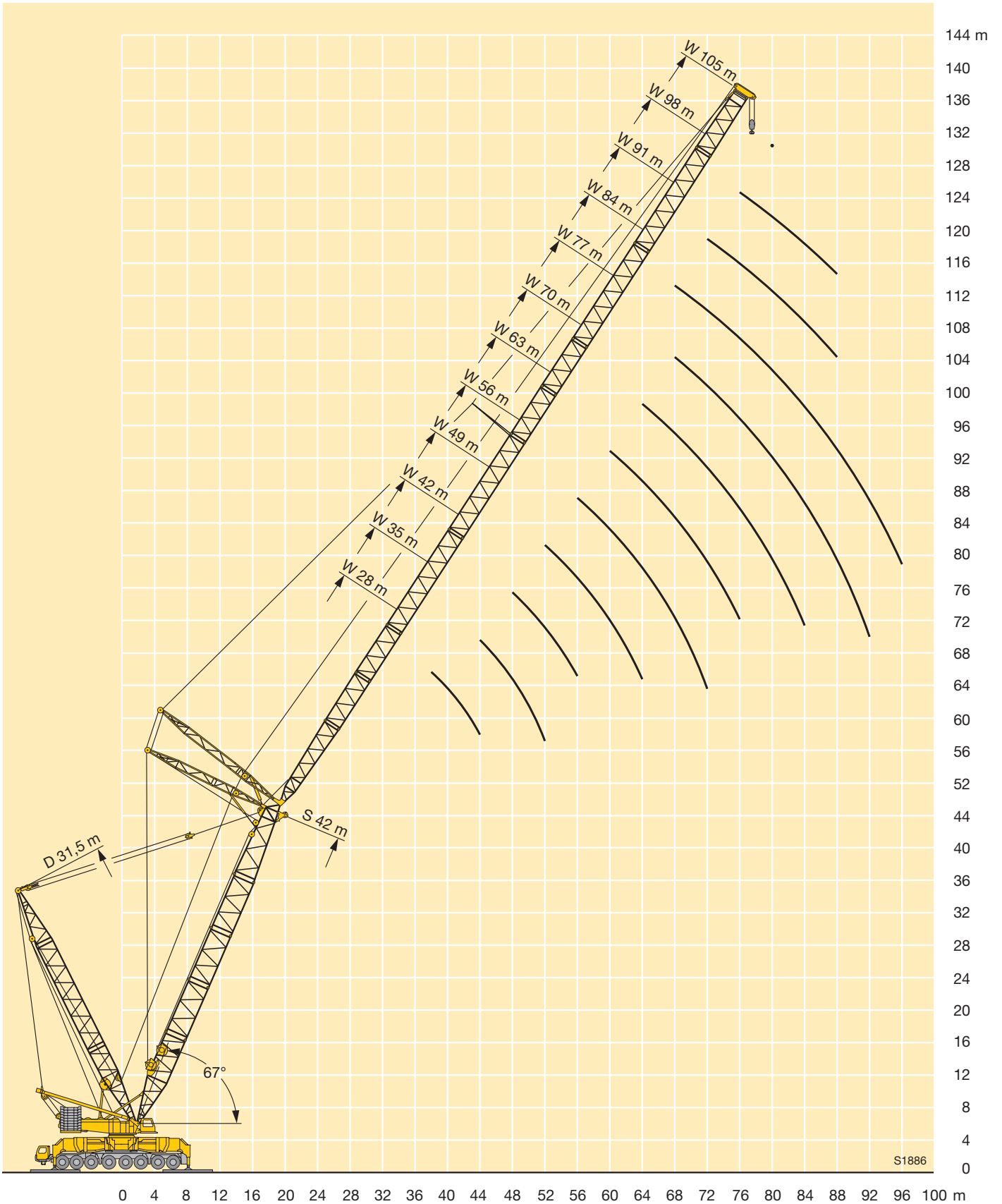

Traglasten am SDWB-Auslegersystem

Lifting capacities on SDWB boom/derrick combination

Forces de levage en configuration SDWB

SDWB

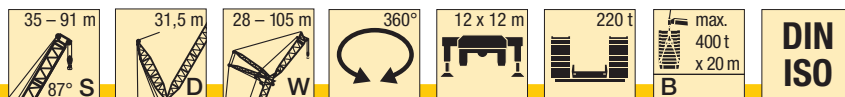

m	35 m											42 m											m		
	28 m	35 m	42 m	49 m	56 m	63 m	70 m	77 m	84 m	91 m	98 m	105 m	28 m	35 m	42 m	49 m	56 m	63 m	70 m	77 m	84 m	91 m		98 m	105 m
14	400												387												14
16	397	351											379	321											16
18	392	342	286										371	313	261										18
20	386	334	280	233	190								359	306	256	211									20
22	354	324	275	229	188	157							346	298	251	209	175	149							22
24	314	310	270	225	186	156	136						323	290	246	206	172	148	124						24
26	283	284	263	221	185	155	135	112					294	281	240	204	170	146	123	106					26
28	255	255	253	217	183	155	134	111	93				265	264	234	201	167	145	123	105	88				28
30	221	233	235	213	181	154	132	110	93	79	65		232	243	229	197	165	144	122	104	87	74			30
32		216	214	208	178	153	131	110	92	78	64	55		224	219	194	163	142	122	103	86	74	62		32
34		196	197	199	174	151	130	109	91	77	64	55		203	205	190	160	141	121	103	86	73	61	52	34
36		173	184	184	171	148	129	108	91	76	63	54		181	191	186	158	139	121	102	85	73	60	51	36
38			172	170	167	146	127	107	90	75	63	54		157	177	177	156	137	120	101	84	72	59	51	38
40			157	160	159	143	126	106	89	74	63	53			162	166	154	135	118	101	83	71	59	50	40
44			125	142	140	136	123	104	88	73	62	52			130	146	144	131	114	98	82	70	57	49,5	44
48				120	124	124	119	102	87	71	61	51				125	128	126	111	96	80	69	56	48,5	48
52					108	112	110	101	86	69	60	50					111	115	108	94	79	67	55	47,5	52
56					90	99	99	96	85	67	58	49					93	102	102	93	78	66	54	46,5	56
60						85	90	89	84	66	56	47,5						89	93	91	77	65	53	45,5	60
64						71	80	82	80	65	55	46,5						74	82	85	76	64	52	44,5	64
68							68	74	74	63	53	45,5							71	76	74	62	51	43,5	68
72								65	68	62	53	44,5								67	69	61	51	42,5	72
76								55	61	61	52	43,5								58	62	59	50	42	76
80									53	56	52	42,5									54	57	50	41	80
84										50	50	42									46	51	49	40,5	84
88										43	46	41,5										44,5	47	40	88
92											40	41											42,5	39,5	92
96											34	37,5											36	38	96
100												32											34	38	100

TAB 154393 / 154394 / 154395 / 154396

m	49 m											56 m											m		
	28 m	35 m	42 m	49 m	56 m	63 m	70 m	77 m	84 m	91 m	98 m	105 m	28 m	35 m	42 m	49 m	56 m	63 m	70 m	77 m	84 m	91 m		98 m	105 m
14	345																								14
16	345	289																							16
18	336	282	236																						18
20	326	276	231	196																					20
22	316	270	227	193	162																				22
24	306	263	223	190	160	137																			24
26	294	256	218	187	158	135	115	99																	26
28	273	249	213	184	156	133	114	98	82																28
30	242	241	209	181	155	132	112	97	81	70															30
32		229	205	177	153	130	111	96	80	69	58														32
34		209	201	174	150	129	109	95	80	69	58	49													34
36		188	194	171	148	128	108	94	79	68	57	48,5													36
38		164	183	168	146	126	107	93	79	68	57	48													38
40			167	165	144	125	106	93	78	67	56	47,5													40
44			136	149	140	123	104	91	77	66	55	47													44
48				128	130	120	103	89	76	65	54	46													48
52					114	115	101	87	75	64	53	45,5													52
56					97	104	98	86	73	62	52	44,5													56
60						91	93	84	72	61	51	43,5													60
64						76	84	82	71	60	50	42,5													64
68							73	77	70	59	49	41,5													68
72								69	69	58	48	41													72
76								59	64	57	47,5	40													76
80									56	56	47	39,5													80
84									47,5	52	46	38,5													84
88										45,5	45,5	38													88
92											43	37,5													92
96												37,5													96
100													34,5												100
104														29,5											104

TAB 154393 / 154394 / 154395 / 154396

Traglasten am SDWB-Auslegersystem

Lifting capacities on SDWB boom/derrick combination

Forces de levage en configuration SDWB

SDWB

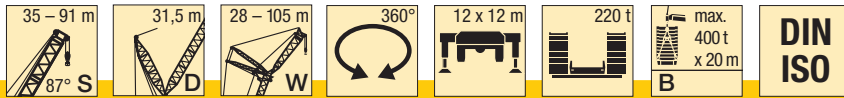

m	63 m													70 m													m
	28 m	35 m	42 m	49 m	56 m	63 m	70 m	77 m	84 m	91 m	98 m	105 m	28 m	35 m	42 m	49 m	56 m	63 m	70 m	77 m	84 m	91 m	98 m	105 m			
16	274												236												16		
18	267	225											229	201											18		
20	260	221	190	160									223	195	169										20		
22	252	216	187	158	137								217	190	167	142									22		
24	244	211	184	155	134	115							211	184	164	141	122	106							24		
26	236	205	181	153	132	113	99						205	179	162	139	120	105	90						26		
28	228	199	177	151	130	112	98	83					199	174	158	138	119	104	88	76					28		
30	220	194	173	149	128	110	97	83	70				192	170	154	136	117	103	87	75	63				30		
32	212	190	169	147	126	108	96	82	69	60	50		187	165	150	133	116	102	87	75	63	55			32		
34		186	165	145	124	107	95	82	68	60	49,5	42,5		161	146	131	114	101	86	74	62	55	45,5		34		
36		182	162	143	123	106	94	81	68	59	49	42		157	142	128	112	100	85	73	62	54	45	39	36		
38		172	158	141	121	105	93	81	67	59	48,5	41,5		154	139	125	110	98	84	73	62	54	44,5	38,5	38		
40			155	139	120	104	92	81	67	58	48,5	41,5			135	122	108	97	83	72	61	54	44,5	38	40		
44			138	131	116	103	89	79	66	58	47,5	41			129	117	104	94	81	71	61	53	43,5	37,5	44		
48				126	112	101	87	77	65	57	47	40,5				111	100	92	79	69	59	52	43	37	48		
52				107	108	97	85	75	64	56	46	40				107	97	89	77	67	58	52	42	36	52		
56					98	93	83	73	64	55	45	39				93	85	76	66	56	51	41	35,5	56			
60						89	81	71	63	54	44	38,5				82	74	65	55	51	40	34,5	60				
64						78	80	70	62	53	43	38				79	72	63	54	50	39,5	34	64				
68							73	69	60	52	42	37					69	62	53	50	38,5	33,5	68				
72								62	67	58	51	41,5	36,5					64	61	53	48,5	38	32,5	72			
76									61	57	50	41	36						59	52	47	37	32	76			
80										55	49,5	40	35,5							51	45,5	36,5	31,5	80			
84										48,5	49	39,5	35							48,5	44,5	36	31	84			
88											46	39	34								43,5	35,5	31	88			
92												38,5	33,5								40,5	35	30,5	92			
96													37	33								35	30,5	96			
100														33									30,5	100			
104															30,5								30	104			

TAB 154393 / 154394 / 154395 / 154396

m	77 m										84 m										m				
	35 m	42 m	49 m	56 m	63 m	70 m	77 m	84 m	91 m	98 m	105 m	42 m	49 m	56 m	63 m	70 m	77 m	84 m	91 m	98 m		105 m			
18	177																							18	
20	172	151												134										20	
22	168	148	129											131	115									22	
24	164	145	127	110										129	113	99								24	
26	160	142	125	108	95									126	111	98	85							26	
28	155	139	123	107	94	80	71							123	109	96	84	72						28	
30	151	135	121	106	93	79	70	60						120	107	95	83	72	63	54				30	
32	147	131	119	104	92	79	69	59	51					117	105	94	82	71	63	53	40,5			32	
34	144	128	116	103	91	78	68	58	51	38				115	102	92	81	70	62	53	40	34		34	
36	142	125	114	101	90	77	67	58	51	37,5	32			112	100	90	80	69	62	52	39,5	33,5	26,8	36	
38	139	122	111	99	89	77	66	57	51	37,5	31,5			109	98	88	79	69	61	52	39,5	33,5	26,6	38	
40		120	109	97	87	76	65	57	51	37	31,5			107	95	86	77	68	60	51	39	33	26,3	40	
44			115	104	93	84	74	64	56	50	36,5	31		102	91	83	74	66	59	51	38,5	32,5	25,9	44	
48				100	90	81	72	62	55	50	36	30,5			88	79	72	63	57	49,5	38	32	25,5	48	
52					96	86	78	70	61	54	48,5	35,5	30			84	76	69	61	55	48	37	31,5	25,2	52
56						83	75	68	60	53	47	34,5	29,5				73	66	59	53	46,5	36	31	24,8	56
60							72	65	58	52	45,5	34	28,8				71	63	57	51	45	35	30	24,2	60
64								70	63	56	50	44	33	28,1				61	54	49,5	44	34	29,3	23,6	64
68									61	54	49	43	32,5	27,5											68
72										60	53	47,5	41,5	31,5	26,8										72
76											51	46,5	40,5	31	26,3										76
80												45	39,5	30	25,9										80
84													44	38,5	29,5	25,4									84
88															37,5	28,9	25								88
92																37	28,4	24,6							92
96																	28,3	24,3							96
100																		23,9							100
104																									104

TAB 154393 / 154394 / 154395 / 154396

Traglasten am SDWB-Auslegersystem
Lifting capacities on SDWB boom/derrick combination
Forces de levage en configuration SDWB

SDWB

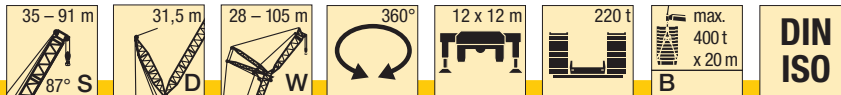

m	91 m									m
	49 m	56 m	63 m	70 m	77 m	84 m	91 m	98 m	105 m	
22	101									22
24	100	88								24
26	98	87	75							26
28	97	85	74	65						28
30	95	84	73	64	56					30
32	93	82	72	63	55	44,5				32
34	91	81	71	62	55	44	36	28,5		34
36	88	79	71	62	54	44	36	28,3	22	36
38	86	77	69	61	53	42	35,5	28	21,8	38
40	84	75	68	60	53	41	35	27,6	21,6	40
44	80	72	65	58	51	40	34,5	27,3	21,2	44
48	77	69	62	55	49,5	39	34	26,8	20,8	48
52	74	66	60	53	47,5	37,5	33	26,4	20,5	52
56		63	57	51	46	36	32	26,1	20,2	56
60		62	55	49	44,5	34,5	31	25,1	19,7	60
64			53	47,5	43	33,5	29,9	24,4	19,2	64
68				45,5	41,5	32,5	29	23,6	18,7	68
72				44	40	31,5	28	22,9	18	72
76					38,5	30	27	22,1	17,5	76
80					37,5	29,2	26,1	21,3	16,9	80
84						28,4	25,2	20,5	16,3	84
88							24,4	19,8	15,6	88
92							23,7	19,1	15,1	92
96								18,5	14,5	96
100									14	100
104									13,4	104

TAB 154393 / 154394 / 154395 / 154396

Hubhöhen am SDBW-Auslegersystem
Lifting heights on SDBW boom/derrick combination
Hauteur de levage en configuration SDBW

SDWB

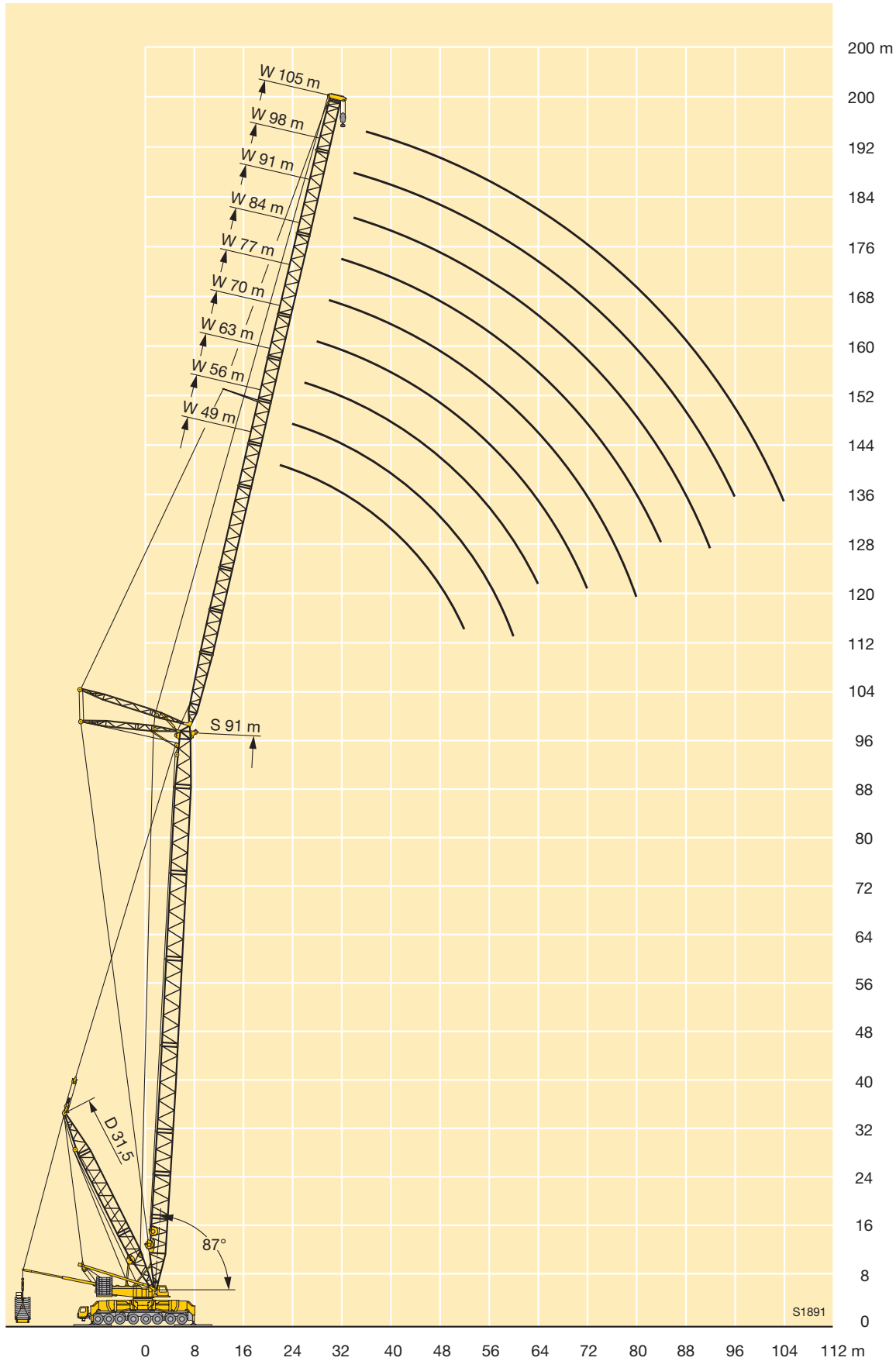

Traglasten am SDWB-Auslegersystem

Lifting capacities on SDWB boom/derrick combination

Forces de levage en configuration SDWB

SDWB

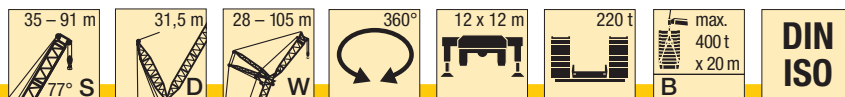

m	35 m											42 m											m			
	28 m	35 m	42 m	49 m	56 m	63 m	70 m	77 m	84 m	91 m	98 m	105 m	28 m	35 m	42 m	49 m	56 m	63 m	70 m	77 m	84 m	91 m		98 m	105 m	
24	334																								24	
26	316																									26
28	300	290																								28
30	286	276	251																							30
32	273	264	249																							32
34	258	249	238	203																						34
36	238	236	226	201	164																					36
38		216	214	199	163	142																				38
40		202	201	193	163	141																				40
44			173	173	160	140	119	99																		44
48			153	150	151	137	119	99	81																	48
52				135	132	132	117	98	81	68																52
56				118	120	118	116	98	80	67	55	46														56
60					108	106	106	97	80	65	54	45,5														60
64						97	95	94	80	64	54	45,5														64
68						86	88	87	80	64	53	45														68
72							80	80	76	63	53	44														72
76							69	73	70	62	52	43,5														76
80								66	65	61	52	43														80
84									60	59	52	42,5														84
88									54	55	52	42														88
92										51	50	41,5														92
96											43,5	46,5	41													96
100												42	41													100
104																										104
108																										108

TAB 154397 / 154398 / 154399 / 154400

m	49 m											56 m											m			
	28 m	35 m	42 m	49 m	56 m	63 m	70 m	77 m	84 m	91 m	98 m	105 m	28 m	35 m	42 m	49 m	56 m	63 m	70 m	77 m	84 m	91 m		98 m	105 m	
28	282																									28
30	269	260																								30
32	257	248																								32
34	246	238	213																							34
36	237	229	212	176																						36
38	227	220	210	175																						38
40	214	212	205	174	143																					40
44		190	189	171	142	123																				44
48			171	167	140	122	102	86																		48
52			151	153	137	122	102	86	71																	52
56				138	134	121	102	86	71	60	49															56
60				116	122	119	101	86	71	60	48,5	40,5														60
64					107	108	101	86	71	60	48,5	40,5														64
68						98	97	85	71	59	48	40,5														68
72						85	89	85	71	59	48	40,5														72
76							80	80	71	58	47,5	40														76
80								74	71	57	47	40														80
84								66	67	57	46,5	39,5														84
88									62	57	46,5	39														88
92									54	56	46,5	39														92
96										50	46,5	39														96
100											46,5	38,5														100
104											42	38,5														104
108												38,5														108
112												34														112

TAB 154397 / 154398 / 154399 / 154400

Traglasten am SDWB-Auslegersystem

Lifting capacities on SDWB boom/derrick combination

Forces de levage en configuration SDWB

SDWB

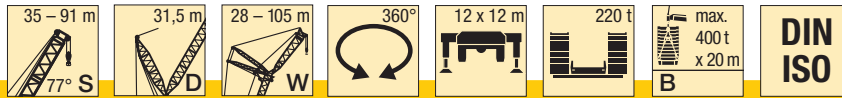

m	63 m											70 m											m					
	28 m	35 m	42 m	49 m	56 m	63 m	70 m	77 m	84 m	91 m	98 m	105 m	28 m	35 m	42 m	49 m	56 m	63 m	70 m	77 m	84 m	91 m		98 m	105 m			
32	239																								32			
34	229	212											213													34		
36	218	211											206	183												36		
38	204	203	176										194	181	155											38		
40	193	191	175	146									182	176	154											40		
44		170	170	146	122								163	161	149	132	113									44		
48		154	153	144	122	105	89							145	143	128	112	96								48		
52			139	137	120	105	89	74							131	125	111	96	81							52		
56			127	125	119	104	89	74	61						120	117	108	95	81	68	57					56		
60				115	113	103	88	74	61	52	42				108	105	94	81	68	57	48					60		
64					104	102	88	74	61	52	42	35,5				98	80	68	57	48	39,5	32				64		
68					97	95	87	74	61	52	42	35,5				91	89	79	68	57	48	39,5	32			68		
72						88	86	74	61	52	41,5	35,5					82	78	68	57	48	39	32			72		
76						81	80	73	61	52	41,5	35,5				76	74	67	57	48	39	32				76		
80							75	73	61	52	41,5	35,5						69	67	57	48	38,5	32			80		
84								69	61	52	41	35,5						65	63	57	48	38,5	32			84		
88								63	61	52	41	35							59	57	48	38	32			88		
92									59	52	41	35									54	48	37,5	32			92	
96									51	52	41	35									51	48	37,5	31,5			96	
100										49	41	35										45,5	37,5	31,5			100	
104											41	35											43	37,5	31,5			104
108											40	35												37,5	31,5			108
112												35													31,5			112
116													35												31,5			116

TAB 154397 / 154398 / 154399 / 154400

m	77 m										84 m										m								
	35 m	42 m	49 m	56 m	63 m	70 m	77 m	84 m	91 m	98 m	105 m	42 m	49 m	56 m	63 m	70 m	77 m	84 m	91 m	98 m		105 m							
38	157																										38		
40	154	137																										40	
44	147	132	117											115														44	
48	137	127	113	100										110														48	
52	124	122	109	98	86	73								105	96	85	75											52	
56		113	105	95	84	73	61							102	92	82	73	64	56									56	
60			101	92	82	72	61	52	44					97	89	80	71	63	56	46,5								60	
64			93	89	80	71	61	52	44	32,5					86	77	69	61	55	46,5	36							64	
68				84	77	69	60	52	44	32,5	26,3				80	75	67	59	53	46,5	36	28,4	21,8					68	
72				78	75	68	59	52	44	32	26,3					73	65	57	52	45	36	28,4	21,8					72	
76					70	66	58	52	44	32	26,3					63	56	51	44	35	28,4	21,8						76	
80						64	57	51	44	31,5	26,3					61	55	49,5	43	34,5	28,3	21,8						80	
84							60	56	50	43,5	31,5	26,3					53	48	42	33,5	28,1	21,8						84	
88								54	49	42,5	31,5	26,3						47	41	33	27,9	21,8						88	
92								50	48,5	42	31	26,2						46	40,5	32	27,5	21,8						92	
96									46	41,5	31	26							39,5	31,5	27	21,4						96	
100										41	31	26							38,5	31	26,4	21						100	
104											38,5	31	26								30	25,9	20,5					104	
108												31	26										25,3	20,1					108
112												29,4	26										24,8	19,7					112
116													25,4											19,4					116
120																									18,6				120

TAB 154397 / 154398 / 154399 / 154400

Traglasten am SDWB-Auslegersystem
Lifting capacities on SDWB boom/derrick combination
Forces de levage en configuration SDWB

SDWB

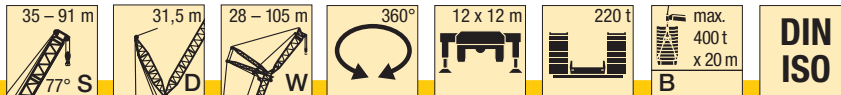

m	91 m									m
	49 m	56 m	63 m	70 m	77 m	84 m	91 m	98 m	105 m	
48	86									48
52	82	74	64							52
56	79	71	63	56						56
60	76	68	61	55	47,5					60
64	74	66	58	53	46,5	36	31			64
68	72	64	56	51	45	35,5	30,5	23,6		68
72		62	54	49,5	43,5	34	30	23,6	17,8	72
76		61	53	48	42	33	29,2	23,5	17,8	76
80			52	46,5	41	32	28,4	22,8	17,8	80
84				45	39,5	31	27,5	22,1	17,2	84
88				44	38,5	30	26,7	21,5	16,7	88
92					37,5	29,4	26	20,8	16,1	92
96						28,7	25,2	20,2	15,6	96
100						27,9	24,5	19,6	15,1	100
104							23,9	19,1	14,7	104
108							23,3	18,5	14,2	108
112								18	13,7	112
116									13,3	116
120									12,9	120

TAB 154397 / 154398 / 154399 / 154400

Hubhöhen am SDBW-Auslegersystem
Lifting heights on SDBW boom/derrick combination
Hauteur de levage en configuration SDBW

SDWB

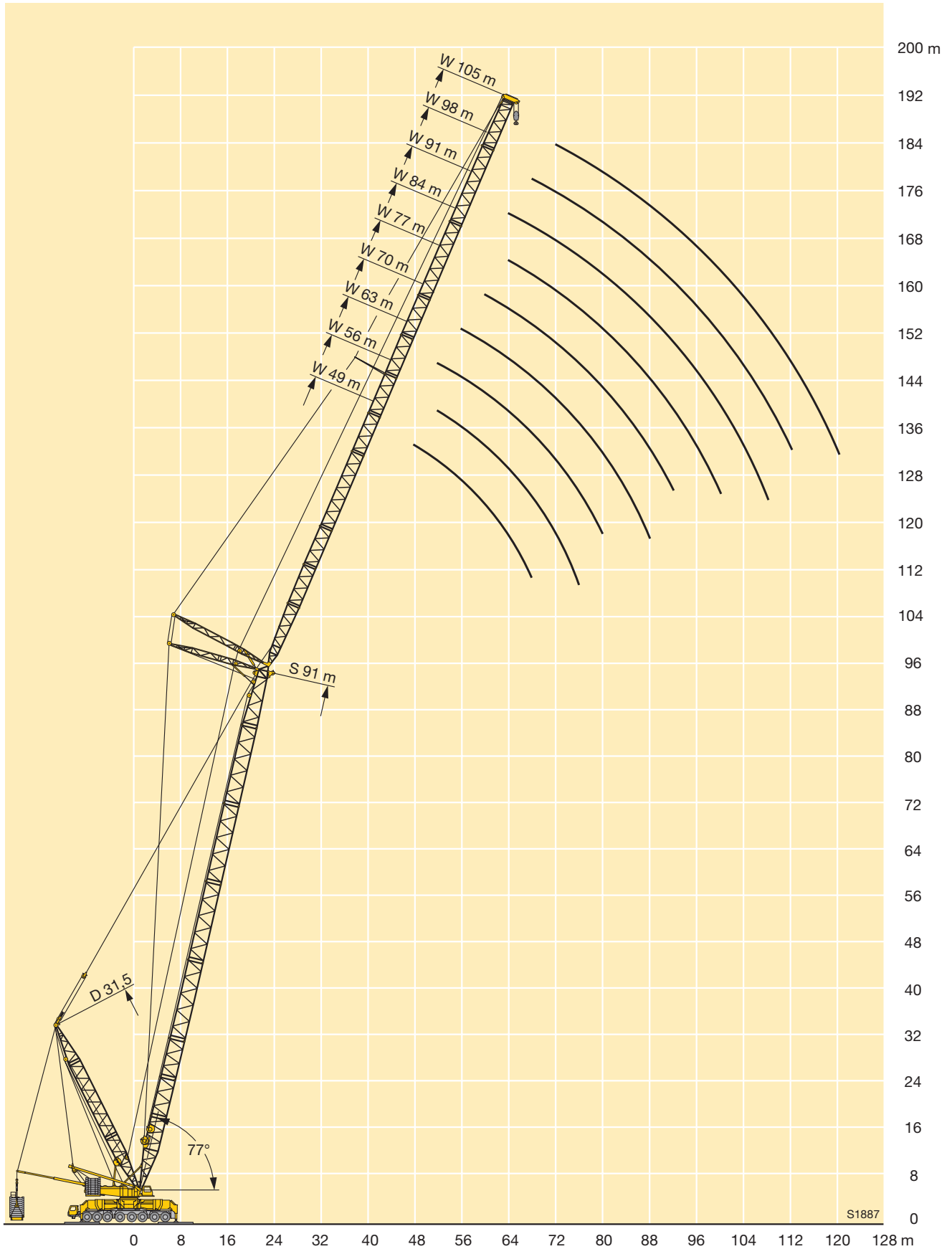

Traglasten am SDWB-Auslegersystem

Lifting capacities on SDWB boom/derrick combination

Forces de levage en configuration SDWB

SDWB

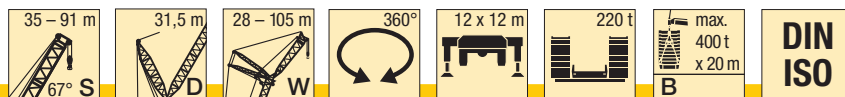

m	35 m											42 m											m				
	28 m	35 m	42 m	49 m	56 m	63 m	70 m	77 m	84 m	91 m	98 m	105 m	28 m	35 m	42 m	49 m	56 m	63 m	70 m	77 m	84 m	91 m		98 m	105 m		
34	233																								34		
36	219																									36	
38	208	203											224													38	
40	197	192											211													40	
44		175	169										189	187												44	
48		160	155	148										169	166											48	
52			143	136	134									154	152	146										52	
56			134	126	125	118									139	136	133									56	
60				119	117	111	106									126	124	116								60	
64					109	105	101	89								117	115	101								64	
68					101	100	94	88	72								106	104	100	82	67					68	
72						91	89	84	72	60							99	97	95	82	67	56				72	
76						83	82	81	72	60	47,5							90	89	82	67	56	44,5			76	
80							76	75	70	60	47,5	40							83	81	67	56	44,5	37		80	
84								69	66	60	47,5	40							76	74	67	56	44,5	37		84	
88								64	60	60	47,5	40								69	67	56	44,5	37		88	
92									58	56	47,5	40								62	62	56	44,5	37		92	
96										52	47,5	40									58	56	44,5	37		96	
100										48,5	47	40										53	44,5	37		100	
104											44	40											49	44,5	37		104
108											40,5	39,5												44	37		108
112												36,5													37		112
116																									37		116

TAB 154402 / 154403 / 154404 / 154405

m	49 m											56 m											m			
	28 m	35 m	42 m	49 m	56 m	63 m	70 m	77 m	84 m	91 m	98 m	105 m	28 m	35 m	42 m	49 m	56 m	63 m	70 m	77 m	84 m	91 m		98 m	105 m	
40	210																									40
44	188	186																								44
48	170	168	166																							48
52		152	151	148																						52
56			138	136	131																					56
60			127	125	123	114																				60
64				115	114	111	93																			64
68				107	105	103	93	77																		68
72					98	96	93	77	62																	72
76						89	88	77	62	53																76
80						84	82	77	62	53	41,5															80
84							77	76	62	53	41,5	35														84
88							72	71	62	53	41,5	35														88
92								67	62	53	41,5	35														92
96									61	53	41,5	35														96
100									57	53	41,5	35														100
104										53	41,5	35														104
108											41,5	35														108
112											41,5	35														112
116												35														116
120													35													120

TAB 154402 / 154403 / 154404 / 154405

Traglasten am SDWB-Auslegersystem

Lifting capacities on SDWB boom/derrick combination

Forces de levage en configuration SDWB

SDWB

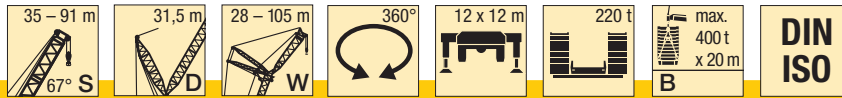

m	63 m											70 m											m					
	28 m	35 m	42 m	49 m	56 m	63 m	70 m	77 m	84 m	91 m	98 m	105 m	28 m	35 m	42 m	49 m	56 m	63 m	70 m	77 m	84 m	91 m		98 m	105 m			
48	158																								48			
52	144	141												137	134											52		
56		129	127											125	123	120										56		
60		119	117	114											113	110	108									60		
64			108	105	103											99	98									64		
68				98	96	94										92	90	87								68		
72				91	89	87	80									85	84	81	73							72		
76					83	81	78	67								80	78	75	73	61						76		
80					78	75	73	67	56							73	70	68	61	51						80		
84						70	68	67	55	46							65	64	61	51	42					84		
88							64	63	55	46	36						61	60	57	51	42	33				88		
92							60	58	55	46	36	29,7						56	54	51	42	33	27,2			92		
96								55	54	46	36	29,7							50	49	42	33	27,2			96		
100								52	50	46	36	29,7							47	46	42	33	27,2			100		
104									47,5	45,5	36	29,7								43	41	33	27,2			104		
108										42,5	36	29,7									40,5	38	33	27,2			108	
112										40	36	29,7										36	33	27,2			112	
116											36	29,7											33,5	32,5	27,2			116
120												29,7												30,5	27,2			120
124												29,7													26,3	124		
128																									24,3	128		

TAB 154402 / 154403 / 154404 / 154405

m	77 m											84 m											m					
	35 m	42 m	49 m	56 m	63 m	70 m	77 m	84 m	91 m	98 m	105 m	42 m	49 m	56 m	63 m	70 m	77 m	84 m	91 m	98 m	105 m							
56	116																									56		
60	106	104																									60	
64	98	96	94											89													64	
68		88	86	84										83	80												68	
72		82	80	77	75									77	74	72											72	
76			74	72	70	67									68	67	64										76	
80				67	65	62	57								64	62	59	58									80	
84				63	61	58	57	46								58	55	53	49,5								84	
88					56	54	53	46	39							54	51	50	47,5	41,5							88	
92					53	50	49,5	46	39	27,4							47,5	46,5	44	41,5	31,5						92	
96						47	46	44	39	27,4	22							43	41	38,5	31,5	24,1					96	
100							43	41	39	27,4	22							40,5	38	36	31,5	24,1	18,2				100	
104								40,5	38	37,5	27,4	22								35,5	33	29,1	24,1	18,2			104	
108									35,5	34,5	27,4	22								33	30,5	26,8	24,1	18,2			108	
112									33,5	32	27,1	22									28,7	24,6	22,7	18,2			112	
116										30	25	22										22,8	20,7	17,3			116	
120											23,3	21,2										21,1	18,8	15,6			120	
124											21,6	19,4											17,3	14,3			124	
128												17,8											15,9	13,1				128
132												16,2												11,9				132

TAB 154402 / 154403 / 154404 / 154405

Traglasten am SDWB-Auslegersystem
Lifting capacities on SDWB boom/derrick combination
Forces de levage en configuration SDWB

SDWB

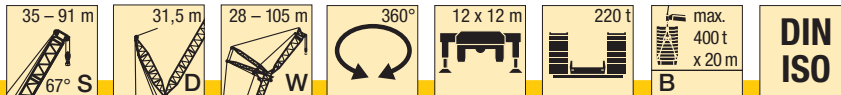

m	91 m									m
	49 m	56 m	63 m	70 m	77 m	84 m	91 m	98 m	105 m	
72	68									72
76	63	60								76
80	59	56	54							80
84	55	52	50	47	40,5					84
88		48,5	46,5	44	40	31				88
92			43	40,5	38	30,5	25,4			92
96			40	37,5	35,5	30,5	25,2	19,3		96
100				35	32,5	28,6	25	19,1	14	100
104				32,5	30	26,3	24	19	13,9	104
108					27,9	24,1	21,9	18,6	13,9	108
112						22,2	19,9	16,7	13,5	112
116						20,5	17,9	14,9	12,2	116
120							16,5	13,2	11	120
124							15,1	11,9	9,9	124
128								11,1	8,8	128
132									8,2	132
136									7,7	136

TAB 154402 / 154403 / 154404 / 154405

Hubhöhen am SDBW-Auslegersystem
Lifting heights on SDBW boom/derrick combination
Hauteur de levage en configuration SDBW

SDWB

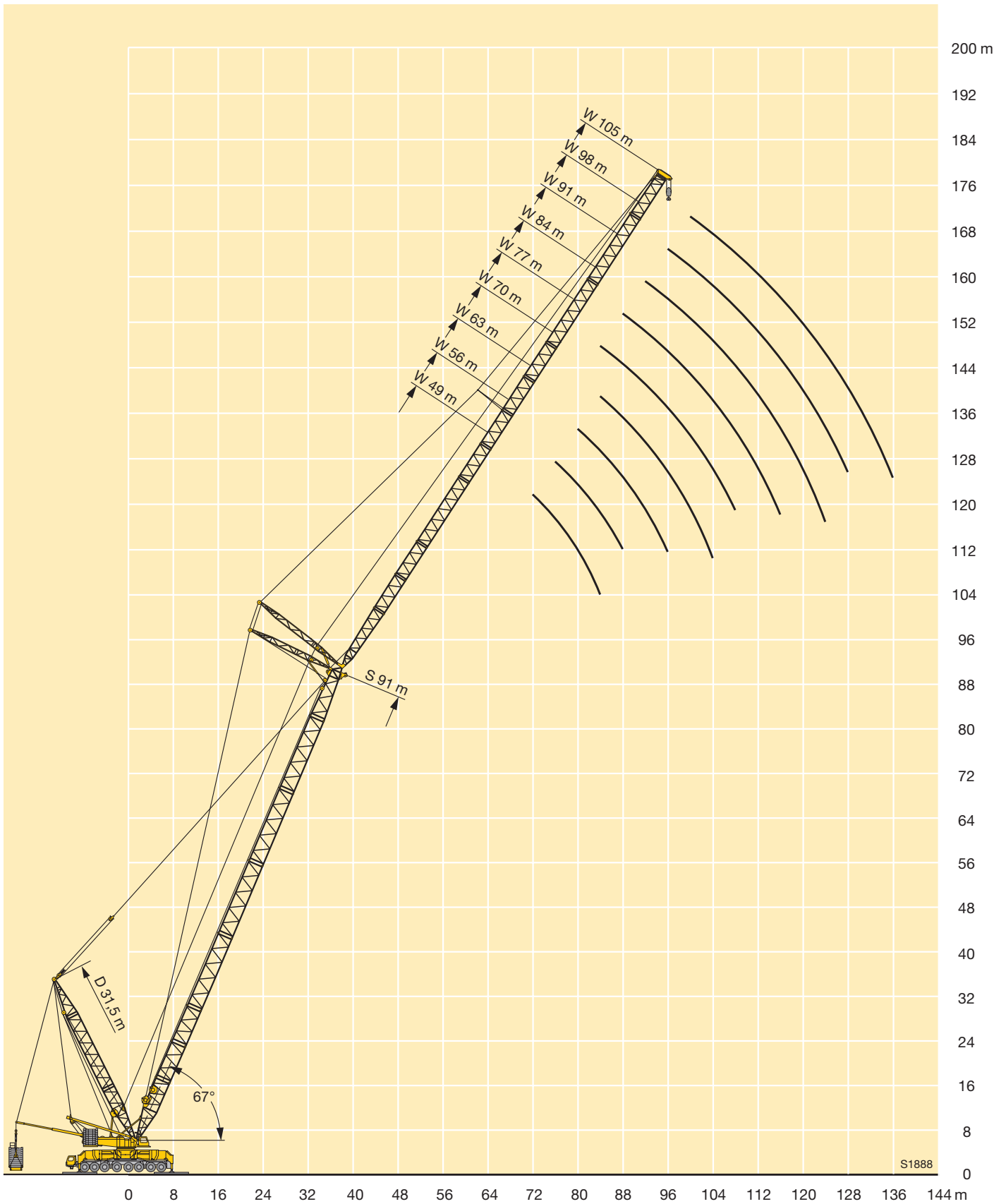

Technische Beschreibung

Technical description

Description technique

Kranfahrgestell

Rahmen	Eigengefertigte, verwindungssteife Stahlkonstruktion aus hochfestem Feinkorn-Baustahl.
Abstützungen	Vier hydraulisch ausklappbare Schwenkholme mit hydraulischen Abstützzyllindern.
Motor	8-Zylinder-Diesel, Fabrikat Liebherr, Typ D9508 A7, wassergekühlt, Leistung 500 kW (680 PS) bei 1900 min ⁻¹ . Max. Drehmoment 3000 Nm bei 1100 min ⁻¹ – 1500 min ⁻¹ . Abgasemissionen entsprechend Richtlinien 97/68/EG Stufe 3 und EPA/CARB Tier 3. Kraftstoffbehälter: 600 l.
Getriebe	Automatisches Getriebesystem mit Wandlerschaltkupplung, Fabrikat ZF, Typ TC-TRONIC mit 12 Vorwärtsgängen und 2 Rückwärtsgängen, Verteilergetriebe mit sperrbarem Längsdifferential.
Achsen	Robuste Kranfahrzeugachsen. Alle Achsen gelenkt, Achsen 1, 2, 4 und 6 sind angetriebene Planetenachsen, Achse 4 mit Längsdifferential, Achsen 4 und 6 mit Querdifferential.
Gelenkwellen	Alle Gelenkwellen mit 70° Kreuzverzahnung.
Federung	Alle Achsen sind hydropneumatisch gefedert mit automatischer Niveauregulierung. Achsdruckausgleich zwischen den Achspaaren 1 + 2, 3 + 4, 5 + 6 und 7 + 8. Federung hydraulisch blockierbar.
Bereifung	16fach, alle Achsen einzeln bereift. Reifengröße: 505/95 R 25 (18.00 R 25).
Lenkung	ZF-Halblock-Hydrolenkung, 2-Kreisanlage mit hydraulischer Servoeinrichtung und zusätzlicher Reservepumpe, von der Achse angetrieben, auf die mechanisch miteinander verbundenen Achsen 1 – 4 wirkend. Bei Straßenfahrt werden die Achsen 5 – 8 elektrohydraulisch gelenkt und ab 30 km/h werden die Achsen 5 + 6 auf Geradeausfahrt gestellt blockiert. Die Achsen 7 + 8 werden geschwindigkeitsabhängig bis 60 km/h in Abhängigkeit des Lenkeinschlages der Vorderachse "aktiv" gelenkt und über 60 km/h auf Geradeausfahrt gestellt wobei die 7. Achse zusätzlich blockiert wird. Lenkung entsprechend EG-Richtlinien 70/311 EWG.
Bremsen	Betriebsbremse: Allrad-Servo-Druckluftbremse, 2-Kreisanlage. Zusatzbremsen: Auspuffklappenbremse, Retarder, im TC-TRONIC-Getriebe, Telma-Wirbelstrombremse (Option). Handbremse: Federspeicher auf alle Räder der 3., 6. und 8. Achse wirkend. Bremsen entsprechend EG-Richtlinien 71/320 EWG.
Fahrerhaus	Großräumige Kabine in Stahlblechausführung, gummielastisch aufgehängt. Sicherheitsverglasung.
Elektr. Anlage	Moderne Datenbus-Technik, 24 Volt Gleichstrom, 2 Batterien je 170 Ah.

Kranoberwagen

Rahmen	Eigengefertigte, verwindungssteife Schweißkonstruktion aus hochfestem Feinkorn-Baustahl. Verbindung zum Kranfahrgestell über 3-reihige Rollendrehverbindung mit Quick Connection, 360° unbegrenzt schwenkbar. Schnellverbindung zum leichten Trennen von Kranoberwagen und Kranfahrgestell.
---------------	---

Demontagevorrichtung A-Bock	Zur Demontage von A-Bock, Winde 4 und kompletter Einscherung.
Kranmotor	8-Zylinder-Diesel, Fabrikat Liebherr, Typ D9508 A7, wassergekühlt, Leistung 400 kW (544 PS) bei 1800 min ⁻¹ . Max. Drehmoment 2546 Nm bei 1500 min ⁻¹ . Abgasemissionen entsprechend Richtlinien 97/68/EG Stufe 3A und EPA/CARB Tier 3. Kraftstoffbehälter: 820 l.
Kranantrieb	Diesel-hydraulisch über Pumpenverteilergetriebe mit 6 Axialkolben-Verstellpumpen mit Leistungsregelung, geschlossene Ölkreisläufe.
Kransteuerung	Servosteuerung mit elektronischer Gleichlauf-einrichtung über drei 4fach Kreuzsteuerhebel und zwei 2fach Steuerhebel. Stufenlose Regulierung der Kranbewegungen durch Verstellen der Hydraulikpumpen und zusätzlich durch Veränderung der Dieselmotor-Drehzahl.
Winden 2 und 4	Hydraulisch angetriebene Seiltrommel über Axialkolben-Verstellmotor und Planetengetriebe mit federbelasteter, hydraulisch löfbarer Haltebremse. Verschleißfreies Bremsen beim Senkvorgang über geschlossene Ölkreisläufe. Winde 2 - Hubwerk, Winde 4 - Einziehwerk. Zusätzlich Hilfswinde zum Einscheren von Seilen.
Drehwerk	1 Drehwerk (2 als Option), hydraulisch angetrieben über Axialkolben-Verstellmotor und Planetengetriebe mit federbelasteter, hydraulisch löfbarer Haltebremse. Verschleißfreies Bremsen über geschlossenen Ölkreislauf.
Krankabine	Großräumige Kabine in Stahlblechausführung, seitlich schwenkbar und nach hinten neigbar, mit Bedienungs- und Kontrollinstrumenten und motorunabhängiger Warmwasserheizung (Klimaanlage als Option).
Sicherheitseinrichtungen	LICCON-Überlastanlage mit Testsystem, Hubendbegrenzung, elektronische Neigungsanzeige, Sicherheitsventile gegen Rohr- und Schlauchbrüche, Windmesser.
Elektrische Anlage	Datenbus-Technik, 24 V Gleichstrom, 2 Batterien á 170 Ah.
Drehbühnenballast	170 t, bestehend aus 2 Konsolen á 10 t und 12 Platten á 12,5 t.

Auslegersysteme

SL - Hauptausleger	SL 28 – 133 m (SL 112 m – 133 m nur mit Derrick), System 2826.30 / 2826.20 / 2421.10 Anlenkstück 12 m, Zwischenstück 7 m und 14 m, Reduzierstück 7 m, Kopfadapter 8,4 m, 400 t-Kopfstück 0,6 m, Anti-Rückfallzylinder.
S - Hauptausleger	S 21 – 140 m (S 91 m – 140 m nur mit Derrick), System 2826.30 / 2826.20 / 2826.10 Anlenkstück 12 m, Zwischenstücke 7 m und 14 m, Kopfstück 9 m, Rollensatz 400 t (600 t als Option), Anti-Rückfallzylinder.
D-Derrickausleger	D 31,5 m, System 2421.10 Anlenkstück 10,5 m, Zwischenstück 14 m, Kopfstück 7 m, Verstellflasche, Anti-Rückfallzylinder.
W-Wippbare Gitterspitze	W 28 – 105 m, System 2421.10 / 2421.8 Anlenkstück 12 m, Zwischenstücke 7 m und 14 m, Kopfadapter 8,4 m, 400 t-Kopfstück 0,6 m, Anti-Rückfalleinrichtung, A-Bock 1 und 2.
B-Schwebeballast	Schwebeballastpalette mit Ausgleichszylinder und hydraulisch teleskopierbarer Führung für max. 400 t Derrickballast bei max. 20 m Gegenausladung.

Technische Beschreibung Technical description Description technique

Zusatzausrüstung

Winden 1, 3, 5 und 6	Winde 1 – Hubwerk, Winde 3 – Verstellung Hauptausleger/D-Betrieb, Winde 5 – Verstellung wippbare Gitterspitze, Winde 6 – Zusatzhubwerk.
Ballast	Drehbühnenballast 245 t, zusätzlich 6 Platten à 12,5 t. Schwebeballast B 387,5 t, 31 Platten à 12,5 t für gesamt 400 t Derrickballast.
Drehbühnenverlängerung	Verlängerung der Drehbühne um 2,5 m. Erhöhung des Drehbühnenballastes um 5 t auf gesamt 250 t.
Mobile Bolzenzieheinrichtung	Zur Montage/Demontage der Ausleger-Zwischenstücke.
Mastnasen	Mastnase 60 t, zum Anbau an SL-, W-Kopf. Mastnase 60 t, zum Anbau an S-Kopf. Mastnase 120 t.

Weitere Zusatzausrüstung auf Anfrage.

Crane carrier

Frame	Self-manufactured, torsion-resistant box-type design of high-tensile grain refined structural steel.
Outriggers	Four hydraulically unfolding swing-out outriggers with hydraulic supporting rams.
Engine	8-cylinder Diesel, make Liebherr, type D9508 A7, watercooled, output 500 kW (680 h.p.) at 1900 min ⁻¹ , max. torque 3000 Nm at 1100 min ⁻¹ – 1500 min ⁻¹ . Exhaust emissions acc. to 97/68/EG stage 3 and EPA/CARB Tier 3. Fuel reservoir: 600 l.
Transmission	Automatic transmission with converter control clutch, make ZF, type TC-TRONIC with 12 forward speeds and 2 reverse speeds, transfer case with lockable longitudinal differential.
Axles	Robust crane carrier axles. All axles steered, axles 1, 2, 4 and 6 are driven planetary axles, axle 4 with longitudinal differential, axles 4 and 6 with transverse differential.
Cardan shafts	All cardan shafts with 70° diagonal toothing.
Suspension	All axles with hydropneumatic suspension with automatic levelling control. Axle pressure equalization between the axle pairs 1 + 2, 3 + 4, 5 + 6 and 7 + 8. The suspension can be blocked hydraulically.
Tyres	16-fold, all axles equipped with single tyres. Tyre size: 505/95 R 25 (18.00 R 25).
Steering	ZF semi-integral power steering, 2-circuit system with hydraulic servo mechanism and additional axle-driven emergency pump acting on the mechanically interlinked axles 1 – 4. Axles 5 – 8 are steered electrohydraulically during road displacement and from 30 km/h, axles 5 + 6 are set to straight displacement and locked. Axles 7 + 8 are “actively” steered up to 60 km/h dependent on the cramp of the front axle and beyond 60 km/h, set to straight displacement and axle 7 is locked in addition. Steering in accordance with EC recommendation 70/311 EEC.

Brakes	Service brake: All-wheel servo-air brake, 2-circuit system. Additional brakes: Exhaust pipe retarder, retarder in the TC-TRONIC transmission, TELMA-type eddy-current brake (optional). Hand brake: Spring-loaded brake, acting on all wheels of the 3 rd , 6 th and 8 th axle. Brakes acc. to EG directives 71/320 EEC.
Driver's cab	Spacious cab of sheet steel, on rubber shock absorbers. Safety glass windows.
Electrical system	Modern data bus technology, 24 Volt DC, 2 batteries of 170 Ah each.

Crane superstructure

Frame	Self-manufactured, torsion-resistant weldment of high-tensile grain refined structural steel. Connected to crane carrier by a 3-row roller slewing with Quick Connection rim for 360° continuous rotation. Rapid coupling system to facilitate dismantling the crane superstructure from the crane carrier.
Dismounting device A-Frame	For dismantling the A-frame, winch 4 and the entire reeving.
Crane engine	8-cylinder Diesel, make Liebherr, type D9508 A7, watercooled, output 400 kW (544 h.p.) at 1800 min ⁻¹ , max. torque 2546 Nm at 1500 min ⁻¹ . Exhaust emissions acc. to 97/68/EG stage 3A and EPA/CARB Tier 3. Fuel reservoir: 820 l.
Crane drive	Diesel-hydraulic by pump distribution gear with 6 axial piston variable displacement pumps with capacity control within closed oil circuits.
Crane control	Servo-control with electronic synchronizing device by three four-way control levers and two two-way control levers (joy-stick type). Continuous control of the crane motions by variation of the hydraulic pumps, additionally by variation of the Diesel engine speed.
Winches 2 and 4	Hydraulically driven cable drums by axial piston variable displacement motor and planetary gear with spring-loaded, hydraulically releasable static brake. Wearfree braking function during lowering by closed oil circuits. Winch 2 – hoist gear, winch 4 – derrick gear. Additional auxiliary winch for reeving of cables.
Slewing gear	1 slewing gear (optionally 2), hydraulically powered by axial piston variable displacement motors and planetary gear with spring-loaded, hydraulically releasable static brake. Wearfree braking function by closed oil circuits.
Crane cabin	Spacious, all-steel construction cabin, swivelling sideways and tiltable backwards, with operating and control instruments. Self-contained warm-water heating (optionally air-conditioning system).
Safety devices	LICCON safe load indicator with test system, hoist limit switches, electronic inclinometer, safety valves for the prevention of pipe and hose ruptures.
Electrical system	Data bus technique, 24 V DC, 2 batteries 170 Ah each.
Counterweight on superstructure	170 t, consisting of 2 brackets of 10 t each and 12 slabs of 12.5 t each.

Technische Beschreibung

Technical description

Description technique

Boom systems

SL - Main boom	SL 28 – 133 m (SL 112 m – 133 m, exclusively with derrick), system 2826.30 / 2826.20 / 2421.10 Base section 12 m, intermediate sections 7 m and 14 m, reduction section 7 m, boom head adapter 8.4 m, 400-t head section 0.6 m, safety retaining ram.
S - Main boom	S 21 – 140 m (S 91 m – 140 m, exclusively with derrick), system 2826.30 / 2826.20 / 2826.10 Base section 12 m, intermediate sections 7 m and 14 m, head section 9 m, pulley set 400 t (optional 600 t), safety retaining ram.
D - Derrick boom	D 31.5 m, system 2421.10 Base section 10.5 m, intermediate section 14 m, head section 7 m, derricking pulley block, safety retaining ram
W - Luffing fly jib	W 28 – 105 m, system 2421.10 / 2421.8 Base section 12 m, intermediate sections 7 m and 14 m, boom head adapter 8.4 m, 400-t head section 0.6 m, safety retaining ram, A-frame 1 and 2
B - Suspended ballast	Suspended ballast pallet with compensating ram and hydraulic telescoping guide for max. 400 t derrick ballast at max. 20 m counter-radius.

Optional equipment

Winches 1, 3, 5 and 6	Winch 1 – hoist gear, winch 3 – derricking main boom/D-operation, winch 5 – derricking luffing fly jib, winch 6 auxiliary hoist gear.
Ballast	Superstructure ballast 245 t, additionally 6 slabs of 12.5 t each. Suspended ballast B 387.5 t, 31 slabs of 12.5 t each for a total of 400 t derrick ballast.
Extension of the superstructure	Extension of the superstructure by 2,5 m. Increase of the superstructure ballast by 5 t to a total of 250 t.
Portable pin pulling device	For the assembly/disassembly of boom intermediate sections.
Whip lines	Whip line 60 t, to be fitted to the SL-, W-head, Whip line 60 t, to be fitted to the S-head. Whip line 120 t.

Other items of equipment available on request.

Châssis porteur

Châssis	Châssis avec fût central résistant à la torsion, de fabrication Liebherr, en acier à grains fins très résistant.
Stabilisateurs	Quatre poutres télescopiques à déploiement hydraulique, avec vérins de calage hydrauliques.
Moteur	Moteur diesel, 8 cylindres, fabriqué par Liebherr, de type D9508 A7, à refroidissement par eau, de 500 kW (680 ch) à 1900 min ⁻¹ , couple max. 3000 Nm à 1100 min ⁻¹ – 1500 min ⁻¹ . Emissions des gaz d'échappement conformes aux directives 97/68/EG partie 3 et EPA/CARB Tier 3. Capacité du réservoir à carburant: 600 l.
Réducteurs	Système de réducteurs automatique avec convertisseur-embayage, marque ZF, de type TC-TRONIC avec 12 marches AV et 2 marches AR, boîte de transfert avec différentiel longitudinal auto-bloquant.
Essieux	Essieux robustes. Tous essieux directeurs, essieux 1, 2, 4 et 6 moteurs à planétaires, essieu 4 avec différentiel longitudinal, essieu 4 et 6 avec différentiel transversal.
Flasque de croisillons	Tous les flasques de croisillons avec denture en croix 70°.
Suspension	Tous les essieux sont suspendus hydro-pneumatiquement avec une régulation automatique de niveau. Compensation de charge entre les paires d'essieux 1 + 2, 3 + 4, 5 + 6 et 7 + 8. Suspension à blocage hydraulique.
Pneumatiques	16 fois, chaque essieu est équipé de pneus. Monte de pneumatiques : 505/95 R 25 (18.00 R 25).
Direction	Direction hydraulique semi-bloc ZF, 2 circuits avec servocommande hydraulique et pompe de secours supplémentaire, entraînée par l'essieu, action sur les essieux 1 – 4 liés mécaniquement. En mode de déplacement sur route, direction électro-hydraulique des essieux 5 – 8 et conduite en ligne droite activée pour les essieux 5 + 6 à partir de 30 km/h. En fonction de l'angle de braquage de l'essieu avant, direction «active» des essieux 7 + 8 en fonction de la vitesse jusqu'à 60 km/h, et au-delà de 60 km/h conduite en ligne droite activée et essieu 7 bloqué. Direction conforme aux directives européennes CE 70/311 EWG.
Freins	Frein de service : servo-frein pneumatique pour toutes les roues, 2 circuits. Freins supplémentaires : frein avec clapet sur échappement, ralentisseur, monté sur boîte de vitesses TC-TRONIC, frein Telma (en option). Frein à main : accumulateur à ressort, action sur toutes les roues des essieux 3, 6 et 8. Freins selon directive CE 71/320 EWG.
Cabine porteur	Cabine spacieuse en tôle électrozinguée, suspension par silent blocs. Vitres de sécurité.
Circuit électrique	Technologie de bus de données moderne, courant continu 24 Volts, 2 batteries de chacune 170 Ah.

Technische Beschreibung

Technical description

Description technique

Partie tournante

Châssis	Fabrication Liebherr, construction soudée indéformable, en acier grain fin à haute résistance. Relié au porteur par couronne d'orientation à triple rangée de rouleaux avec Quick Connection, orientation illimitée à 360°. Raccord rapide permettant de désolidariser facilement la partie tournante du châssis porteur.
Dispositif de démontage du chevalet de relevage A	Pour le démontage du chevalet de relevage A, du treuil 4 et du mouflage complet.
Moteur de la grue	Moteur diesel Liebherr, 8 cylindres, de type D9508 A7, à refroidissement par eau, de 400 kW (544 ch) à 1800 min ⁻¹ , couple max. 2546 Nm à 1500 min ⁻¹ . Emissions des gaz d'échappement conformes aux directives 97/68/EG partie 3A et EPA/CARB Tier 3. Capacité du réservoir à carburant: 820 l.
Entraînement de grue	Entraînement Diesel hydraulique via un mécanisme de distribution de pompes avec 6 pompes à débit variable à pistons axiaux, avec réglage de la puissance en circuits hydrauliques fermés.
Commande de la grue	Servo-commande avec dispositif de synchronisation électronique, via 4 manipulateurs en croix et 3 manipulateurs à deux positions. Commande des mouvements de la grue en continu, par régulation du débit des pompes et du régime du moteur Diesel.
Treuil 2 et 4	Tambour de câble à entraînement hydraulique, via un moteur à pistons axiaux à cylindrée variable, un train planétaire avec frein à ressort piloté hydrauliquement. Frein quasi-inusable via des circuits hydrauliques fermés pour les mouvements de descente. Treuil 2 – Treuil de levage, Treuil 4-Mécanisme de relevage. Supplémentaire treuil auxiliaire pour le mouflage des câbles.
Mécanisme d'orientation	1 mécanisme d'orientation (2 en option), à entraînement hydraulique via un moteur à pistons axiaux à cylindrée variable et un train planétaire avec frein à ressort et piloté hydrauliquement. Frein quasi-inusable via des circuits hydrauliques fermés.
Cabine du grutier	Cabine spacieuse en tôle d'acier galvanisée, pivotable latéralement et inclinable vers l'arrière, dotée de tous les éléments de contrôle et de commande et d'un système de chauffage par eau chaude indépendant du moteur (climatisation en option).
Dispositifs de sécurité	Contrôleur de charges "LICCON" avec système de test, fin de course de levage, affichage électronique de l'inclinaison, clapets de sécurité contre la rupture de tuyaux et flexibles, anémomètre.
Installation électrique	Technologie de bus de données, 24 V en continu, 2 batteries de 170 Ah chacune.
Contrepoids de la partie tournante	170 t, comprenant 2 plaques de 10 t et 12 plaques de 12,5 t chacune.

Systèmes de flèches

Flèche principale SL	SL de 28 à 133 m (SL de 112 m à 133 m uniquement avec Derrick), système 2826.30 / 2826.20 / 2421.10. Élément de base de 12 m, éléments intermédiaires de 7 m et 14 m, réducteur de 7 m, adaptateur de tête de 8,4 m, élément de tête de 400 t et de 0,6 m, vérin anti-retour.
Flèche principale S	S de 21 à 140 m (S de 91 m à 140 m uniquement avec Derrick), système 2826.30 / 2826.20 / 2826.10. Élément de base de 12 m, éléments intermédiaires de 7 m et 14 m, élément de tête de 9 m, jeu de roues de 400 t (600 t en option), vérin anti-retour.
Flèche Derrick D	D de 31,5 m, système 2421.10. Élément de base de 10,5 m, élément intermédiaire de 14 m, élément de tête de 7 m, palonnier de renvoi, vérin anti-retour.
Fléchette treillis à volée variable W	W de 28 à 105 m, système 2421.10 / 2421.8. Élément de base de 12 m, éléments intermédiaires de 7 m et 14 m, adaptateur de tête de 8,4 m, élément de tête de 400 t et de 0,6 m, dispositif anti-retour, chevalet de relevage A 1 et 2.
Contrepoids suspendu B	Palette de contrepoids suspendu avec vérin de guidage et poutre de télescopage de contrepoids, pour un contrepoids Derrick de 400 t maximum et une contre-portée maximale de 20 m.

Équipement supplémentaire

Treuil 1, 3, 5 et 6	Treuil 1 – Treuil de levage, treuil 3 – treuil de manoeuvre de la flèche principale / Fonctionnement D. Treuil 5 – treuil de manoeuvre de la fléchette treillis à volée variable, treuil 6 - treuil de levage auxiliaire.
Contrepoids	Contrepoids de la partie tournante de 245 t, plus 6 plaques de 12,5 t. Contrepoids suspendu B de 387,5 t, 31 plaques de 12,5 t pour un contrepoids Derrick total de 400 t.
Extension de la tourelle	Extension de la tourelle de 2,5 m. Augmentation de 5 t du contrepoids de la tourelle pour un total de 250 t.
Dispositif d'extraction d'axes mobile	Pour le montage / démontage des éléments intermédiaires de la flèche.
Poulies brin simple	Poulie brin simple de 60 t, pour le montage sur la tête de la flèche principale SL, de la fléchette W. Poulie brin simple de 60 t, pour le montage sur la tête de la flèche S. Poulie brin simple de 120 t.

Autres équipements supplémentaires sur demande.

Anmerkungen zu den Traglasttabellen

1. Für die Kranberechnungen gelten die DIN-Vorschriften lt. Gesetz gemäß Bundesarbeitsblatt von 2/85: Die Traglasten DIN/ISO entsprechen den geforderten Standsicherheiten nach DIN 15019, Teil 2 und ISO 4305 (Prüflast = 1,25 x Hublast + 0,1 x Auslegereigengewicht auf die Ausleger- spitze reduziert). Für die Stahltragwerke gilt DIN 15018, Teil 3. Die bauliche Ausbildung des Krans entspricht DIN 15018, Teil 2 sowie der F. E. M.
2. Die Traglasten sind in Tonnen angegeben.
3. Das Gewicht des Lasthakens bzw. der Hakenflasche sowie der Anschlagmittel ist von den Traglasten abzuziehen.
4. Die Ausladungen sind von Mitte Drehkranz gemessen.
5. Kranbetrieb – wenn nicht speziell dokumentiert – zulässig bis:
Staudruck 50 N/m²
Windgeschwindigkeit 9 m/s
Weitere Angaben über Windgeschwindigkeiten sind der Bedienungsanleitung zu entnehmen.
6. Die Aufstandsfläche muß eben und tragfähig sein.
7. Traglaständerungen vorbehalten.

Remarks referring to load charts

1. When calculating crane stresses and loads, German Industrial Standards (DIN) are applicable, in conformance with new German legislation (published 2/85). The lifting capacities (stability margin) DIN/ISO correspond to DIN 15019, part 2, and ISO 4305 (Tested load = 1.25 x lifting capacity + 0.1 x boom dead weight, reduced to the boom point). The crane's structural steel work is in accordance with DIN 15018, part 3. Design and construction of the crane comply with DIN 15018, part 2 and with F. E. M. regulations.
2. Lifting capacities are given in metric tons.
3. The weight of the load hook and hook blocks as well as of the lifting tackle must be deducted from the lifting capacities.
4. The working radii are measured from the slewing centreline.
5. Unless particularly specified, crane operation is permissible up to a
dynamic pressure of 50 N/m²
wind speed of 9 m/s
For further details in respect to wind speeds refer to the operating instructions.
6. The subsoil must be even and of good bearing capacity.
7. Subject to modification of lifting capacities.

Remarques relatives aux tableaux des charges

1. La grue est calculée selon normes DIN conformément au décret fédéral 2/85. Les charges DIN/ISO respectent les sécurités au basculement requises par les normes DIN 15019, partie 2 et ISO 4305. La structure de la grue est conçue selon la norme DIN 15018, partie 3. La conception générale est réalisée selon la norme DIN 15018, partie 2, ainsi que selon les recommandations de la F. E. M.
2. Les charges sont indiquées en tonnes.
3. Les poids du crochet ou du moufle ainsi que des élingues sont à déduire des charges indiquées.
4. Les portées sont prises à partir de l'axe de rotation de la partie tournante.
5. Sinon spécifié autrement, le service de grue est admissible jusqu'à une
pression dynamique de 50 N/m²
vitesse de vent de 9 m/s
D'autres indications concernant les vitesses de vent sont stipulées dans les instructions de service.
6. Le sol doit être plat et résistant.
7. Charges données sous réserve de modification.